

# LEGO® Collectible Minifigures

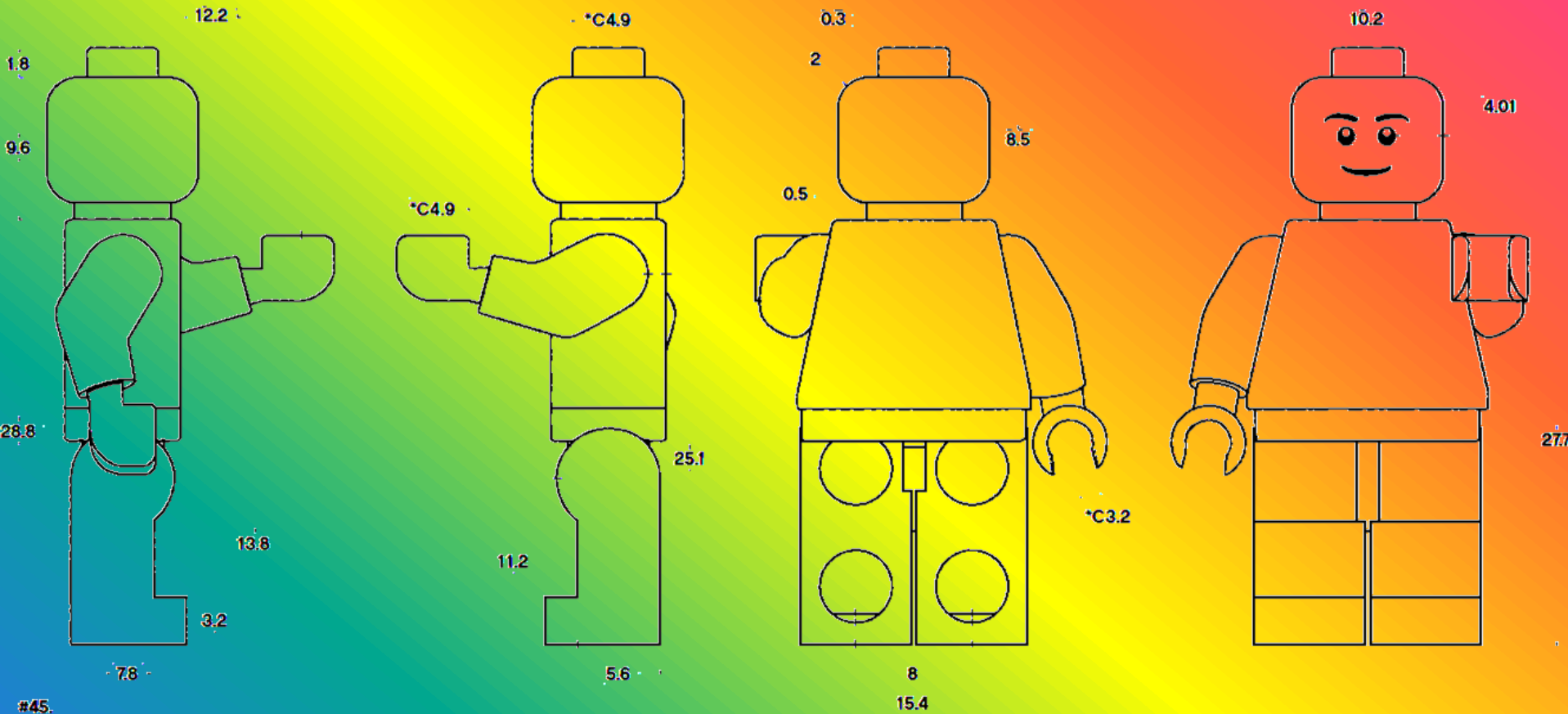

## Series 1-11 Compendium

Covering the 187 Collectible Minifigures



## The LEGO® Collectible Minifigures Series 1-11 Compendium

Compiled and edited by Michael Bradford

Second Edition, October 2013

Comments? email [michael@mortarmagazine.com](mailto:michael@mortarmagazine.com)

LEGO, the LEGO logo, the Minifigure, and the Brick and Knob configurations are trademarks of the LEGO Group of Companies. ©2013 The LEGO Group.







# How to Use This Book

BL Code	# in box	Value	# of parts	# of extras	Face sides	Gender	# of sales	Strength	Creativity	Speed
Bricklink code	How many come in a box of 60	The average sold price (Bricklink)	How many parts are in the bag	Number of extra parts in the bag	How many faces (1 or 2 sides)	The gender (from LEGO website)	Qty. sold in past 6 mos. (Bricklink)	Range 0 to 5 (from LEGO website)	Range 0 to 5 (from LEGO website)	Range 0 to 5 (from LEGO website)

**Zombie**  
"Brillllllllicks..."

BL Code	# in box	Value	# of parts	# of extras	Face sides	Gender	# of sales	Strength	Creativity	Speed
col01-5	3	\$31.83	6	0	1	M	159	3	1	2

Slow in speed and even slower of mind, the lumbering Zombie may look a little scary, but he's completely harmless in every way. Everything he does is slow, mindless and repetitive, from zoning out while watching TV, to waiting in line at the grocery store, to stacking one brick on top of another to build a perfectly even, completely featureless wall that stretches along for miles and miles.

If you interrupt him, he'll just stare at you blankly before going back to whatever he was doing before. If you put an obstacle in front of him, he'll keep bumping into it over and over again until someone turns him around. If you pick him up and move him to a new place, he'll start doing something mindless there instead. The only thing that seems to motivate him is his cherished turkey leg – if you dangle it in front of him, he'll stretch his arms out toward it and follow it wherever it goes.

- The only thing that the Zombie is afraid of is ordinary table salt. It terrifies him!
- The Zombie has watched so much TV that he has become a master of trivia...but nobody ever asks him to share any of it.
- The Zombie loves Halloween. Nobody runs away from him, and everyone thinks he has the best costume.

Minifigure name (taken from official LEGO website).

Background color of the page matches the minifigure series packet and box color. (See bottom of pp. 5-8 for color codes.)

Icons (shown enlarged below) listed for rare figures, MVPs, and fan favorites.

Quote (from LEGO website).

Stats box – shows various stats and information at a glance for this Minifigure. (See above for description of each.)

Biography (from LEGO website).

Pink callouts show fun facts about the accessory or character.

"Did You Know" facts (from LEGO website) on select series.

Page number.



Fan Favorite

"Fan favorite" (as voted on Eurobricks forums polls for each series).

MVP Price is the Minifigure in the series that has sold for the highest average in the past 6 mos on Bricklink (Mar - Aug 2013).

MVP Qty is the Minifigure in the series that has sold the most on Bricklink in the past 6 months (Mar - Aug 2013).

"Rare," "Very Rare," or "Ultra Rare" (see pp. 5-6 for description).

# Fun Facts

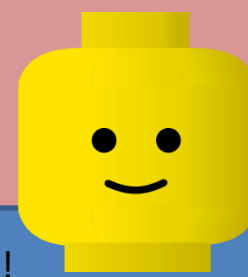

- Every Collectible Minifigure has a unique head design! Some more than one!
- Although Collectible Minifigure heads come in many colors, none come in flesh tones. However, LEGO has made flesh-colored minifigure heads for licensed sets (like Star Wars® and Harry Potter).
- Collectible Minifigures have lots of detailed printing, on fronts and backs of heads, headgear, uniquely printed tiles and accessories, front and back torsos and legs, even the sides of their arms, but only 1 Collectible Minifigure has inner-leg printing (the **Horseback Rider**).
- Series 1 and 2 had an additional barcode on the back of each of their packages making it relatively easy to identify which Minifigure was inside.
- Series 3 and on have “bump codes” on the bottom edge of the packets making it possible to identify which Minifigure is inside.
- Every Collectible Minifigure except the **Toy Soldier** comes with a display stand. Series 1-11 all come with a plain black display stand while Team GB come with a white printed display stand with the Olympic and Team GB logos.
- Although almost all LEGO sets include extras of certain pieces like swords and plumes, LEGO stopped including extras of most pieces after Series 2.
- Most Collectible Minifigure elements are made of ABS plastic; but some are made with rubber.
- Collectible Minifigures come to retailers in boxes of 30, 60, or 120.
- Series 1 and 2 had a Regular Retail Price (RRP) of \$1.99. Series 3-11 had a RRP of \$2.99. Team GB was released only in the UK and Ireland (in recognition of the 2012 Olympics) and had a RRP of £1.99.
- Of the 45 females in Series 1-11, 27 are rare or very rare, and only 1 is common.
- Many of the uniquely designed and produced heads, torsos, legs, and accessories have become available to purchase in the Build-A-Minifig bins at official LEGO stores.
- Every Series 1-11 Minifigure has stats ranging from 0 to 5 in strength, creativity, and speed on LEGO’s website. **Mr. Gold** has the highest stats with a perfect 5 in all areas! The **Hockey Player**, **Downhill Skier**, and **Island Warrior** tie for second best stats with 5’s in strength and speed, and 4 for creativity. The **Sleepyhead** has the lowest stats with only 1 strength, 2 creativity, and 0 speed!



# Rarity

## Ultra Rare

(only 5,000 made globally)

Mr. Gold

## Very Rare

(2 in a box of 60)

Fisherman

Crazy Scientist

Waiter

Hollywood Starlet

Roller Derby Girl

Fortune Teller

Forest Maiden

Plumber

Librarian

Medusa

Bumblebee Girl

Grandpa

Sea Captain

Trendsetter

Scarecrow

Pretzel Girl

Island Warrior

Saxophone Player

Diner Waitress

Grandma

## Rare

(3 in a box of 60)

Tribal Hunter

Cheerleader

Circus Clown

Zombie

Skater

Super Wrestler

Nurse

Spartan Warrior

Explorer

Pop Star

Skier

Disco Dude

Surfer

Pharaoh

Tribal Chief

Snowboarder

Space Villain

Elf

Hula Dancer

Rapper

Lawn Gnome

Musketeer

Viking

Hockey Player

Ice Skater

Graduate

Gladiator

Ice Fisherman

Evil Dwarf

Egyptian Queen

Gangster

Snowboarder Guy

Sleepyhead

Lady Liberty

Clockwork Robot

Roman Soldier

Surgeon

Butcher

Genie

Swimming Champion

Aztec Warrior

Bunny Suit Guy

Bride

Ocean King

Rocker Girl

Grandma Visitor

Lederhosen Guy

Diver

Downhill Skier

Businessman

Fairy

The Thespian

Alien Villainess

## Uncommon

(4 in a box of 60)

Caveman

Robot

Magician

Spaceman

Forestman

Cowboy

Maraca Man

Witch

Vampire

Lifeguard

Mime

Weightlifter

Pilot

Samurai Warrior

Tennis Player

Gorilla Suit Guy

Baseball Player

Kimono Girl

Surfer Girl

The Monster

Street Skater

Soccer Player

Hazmat Guy

Artist

Cave Woman

Lizard Man

Lumberjack

Small Clown

Fitness Instructor

Detective

Classic Alien

Flamenco Dancer

Leprechaun

Skater Girl

Intergalactic Girl

Mechanic

Bagpiper

Daredevil

Tennis Ace

Hippie

Computer Programmer

Viking Woman

Conquistador

Cowgirl

Football Player

Santa

Vampire Bat

Red Cheerleader

Roman Emperor

Chicken Suit Guy

Judge

Mermaid

Battle Mech

Mr. Good and Evil

Warrior Woman

Tomahawk Warrior

Paintball Player

Sad Clown

Revolutionary Soldier

Decorator

Barbarian

Evil Mech

Gingerbread Man

Holiday Elf

Scientist

Lady Robot

# Rarity

## Common

(5 in a box of 60)

Demolition Dummy
Ninja
Deep Sea Diver
Ringmaster
Traffic Cop
Karate Master
Sumo Wrestler
Mummy
Race Car Driver
Space Alien
Punk Rocker
Sailor
Werewolf
Royal Guard
Zookeeper
Boxer
Highland Battler
Bandit
Minotaur
Galaxy Patrol
Jungle Boy
Evil Knight
Evil Robot
DJ
Pirate Captain

## Very Common

(6 in a box of 60)

Cyclops
Heroic Knight
Policeman
Alien Avenger
Roman Commander
Skydiver
Baseball Fielder
Motorcycle Mechanic
Yeti
Mountain Climber
Welder
Constable
Brawny Boxer
Wondrous Weightlifter
Horseback Rider

## Abundant

(7 in a box of 60)

Stealth Swimmer
Relay Runner
Judo Fighter
Tactical Tennis Player
Flexible Gymnast
Agile Archer

## Guaranteed

(1 in every book!)

Toy Soldier
-------------

# Series 1-11, Team GB & Toy Soldier Stats

## 2-sided heads

(10 out of 187)

Boxer
Sleepyhead
Swimming Champion
Daredevil
Galaxy Patrol
Viking Woman
The Thespian
Cyclops
Medusa
Diner Waitress

## Most Parts

(+1 means it came w/an extra part)

Bride	11+1
Viking	10
Evil Dwarf	10
Alien Villainess	10
Heroic Knight	10
Diner Waitress	10
Hippie	9+1
Deep Sea Diver	9
Skier	9
Fisherman	9
Space Villain	9
Leprechaun	9
Intergalactic Girl	9
Viking Woman	9
Downhill Skier	9
Decorator	9
Flexible Gymnast	9
Wondrous Weightlifter	9

## Comes w/Animal

(14 animals)

Vampire	bat
Grandma	cat
Trendsetter	chihuahua
Scarecrow	crow
Fisherman	fish
Ice Fisherman	fish
Zookeeper	chimpanzee
Jungle Boy	chimpanzee
Egyptian Queen	rattlesnake
Mummy	scorpion
Sea Captain	seagull
Mermaid	starfish
Sleepyhead	teddy bear
Holiday Elf	teddy bear

## Comes w/Food

(14 treats!)

Zookeeper	banana
Gorilla Suit Guy	banana
Werewolf	bone
Island Warrior	bone
Bunny Suit Guy	carrot
Zombie	drumstick
Bumblebee Girl	honey
Diner Waitress	ice cream
Small Clown	pie
Yeti	popsicle
Lederhosen Guy	pretzel
Pretzel Girl	pretzel
Butcher	steak
Waiter	wine



# Series 1-11, Team GB & Toy Soldier Stats

## Top 25 in Value

(Bricklink avg Mar-Sep 2013)

Mr. Gold	\$617.44
Zombie	\$23.98
Nurse	\$15.79
Spartan Warrior	\$14.47
Toy Soldier	\$13.35
Circus Clown	\$12.44
Skater	\$10.95
Robot	\$10.85
Roman Soldier	\$9.85
Super Wrestler	\$9.69
Tribal Hunter	\$9.50
Cheerleader	\$9.12
Brawny Boxer	\$8.57
Elf	\$8.23
Forestman	\$7.56
Horseback Rider	\$7.48
Vampire	\$7.46
Wondrous Weightlifter	\$7.41
Cowboy	\$7.12
Surfer	\$6.78
Skier	\$6.75
Ninja	\$6.70
Santa	\$6.65
Spaceman	\$6.54
Relay Runner	\$6.43

## Bottom 25 Value

(Bricklink avg Mar-Sep 2013)

Flamenco Dancer	\$2.30
Boxer	\$2.36
Race Car Driver	\$2.42
Jungle Boy	\$2.43
Skater Girl	\$2.47
Fitness Instructor	\$2.53
Cave Woman	\$2.54
Sumo Wrestler	\$2.54
Detective	\$2.58
Bandit	\$2.60
Zookeeper	\$2.60
Soccer Player	\$2.60
Daredevil	\$2.62
Tennis Ace	\$2.62
Swimming Champion	\$2.63
Mechanic	\$2.65
Tennis Player	\$2.70
Sailor	\$2.70
Lumberjack	\$2.72
Ringmaster	\$2.74
Surfer Girl	\$2.78
Alien Avenger	\$2.80
Baseball Fielder	\$2.80
Traffic Cop	\$2.82
Weightlifter	\$2.84

## Top 25 in Sales

(Bricklink qty sold Mar-Sep 2013)

Roman Commander	3610
Minotaur	2582
Revolutionary Soldier	2138
Clockwork Robot	1913
Lady Liberty	1612
Baseball Fielder	1608
Butcher	1608
Bumblebee Girl	1544
Leprechaun	1526
Genie	1520
Medusa	1460
Sleepyhead	1373
Classic Alien	1353
Warrior Woman	1333
Skydiver	1285
Sad Clown	1285
Tomahawk Warrior	1258
Librarian	1214
Sea Captain	1187
Heroic Knight	1164
Alien Avenger	1138
Bandit	1135
Paintball Player	1131
Gingerbread Man	1126
Trendsetter	1081

## Bottom 25 Sales

(Bricklink qty sold Mar-Sep 2013)

Mr. Gold	27
Stealth Swimmer	107
Judo Fighter	111
Tactical Tennis Player	112
Agile Archer	113
Wondrous Weightlifter	117
Nurse	121
Flexible Gymnast	124
Circus Clown	127
Brawny Boxer	129
Zombie	130
Robot	132
Tribal Hunter	133
Skier	139
Skater	139
Horseback Rider	141
Toy Soldier	143
Pop Star	144
Super Wrestler	145
Forestman	155
Surfer	171
Cheerleader	175
Relay Runner	178
Spaceman	183
Disco Dude	194

# Series 1-11 & Team GB Series Stats

(Series 10 stats on this page do not include Mr. Gold. Average prices, set prices, case prices, and minifig sold data from Bricklink Mar-Sep 2013.)

Series	Release	Part #	Avg price each	RRP	% Inc	Avg # of parts	F	M	N	Minifigs Sold	Avg Set Price	Avg Case Price
1	May-10	8683	\$ 9.53	\$ 1.99	479%	6.875	2	14	0	2927	\$ 152.41	\$ 535.00
2	Sep-10	8684	\$ 5.24	\$ 1.99	263%	6.8125	3	13	0	6123	\$ 83.85	\$ 295.68
3	Jan-11	8803	\$ 3.85	\$ 2.99	129%	6.875	3	12	1	6087	\$ 61.53	\$ 220.11
4	Apr-11	8804	\$ 3.64	\$ 2.99	122%	7.0625	3	13	0	6967	\$ 58.23	\$ 211.26
5	Aug-11	8805	\$ 3.33	\$ 2.99	111%	6.625	4	12	0	7770	\$ 53.31	\$ 196.38
6	Jan-12	8827	\$ 3.81	\$ 2.99	127%	7.25	5	11	0	19196	\$ 61.03	\$ 218.37
7	May-12	8831	\$ 3.39	\$ 2.99	113%	7.4375	5	11	0	8828	\$ 54.16	\$ 200.79
8	Aug-12	8833	\$ 3.96	\$ 2.99	132%	7.4375	5	11	0	5221	\$ 63.30	\$ 233.72
9	Jan-13	71000	\$ 3.77	\$ 2.99	126%	6.625	5	10	1	10317	\$ 60.32	\$ 211.92
10	May-13	71001	\$ 3.71	\$ 2.99	124%	6.625	5	11	0	23058	\$ 59.30	\$ 208.48
11	Sep-13	71002	\$ 3.95	\$ 2.99	132%	6.9375	5	10	1	8392	\$ 63.26	\$ 225.22
TGB	Jul-12	8909	£ 4.18	£ 1.99	210%	7	3	6	0	1132	\$ 60.48	£ 248.73

Series	MVP Price Name	MVP Price	LVP Price Name	LVP price	MVP Qty Name	MVP Qty	LVP Qty Name	LVP qty
1	Zombie	\$ 23.98	Deep Sea Diver	\$ 5.03	Demolition Dummy	385	Nurse	121
2	Spartan Warrior	\$ 14.47	Ringmaster	\$ 2.74	Karate Master	992	Skier	139
3	Elf	\$ 8.23	Race Car Driver	\$ 2.42	Sumo Wrestler	605	Space Villain	216
4	Hockey Player	\$ 5.74	Soccer Player	\$ 2.60	Hazmat Guy	712	Hockey Player	284
5	Gladiator	\$ 4.87	Boxer	\$ 2.36	Boxer	1020	Cave Woman	253
6	Roman Soldier	\$ 9.85	Flamenco Dancer	\$ 2.30	Minotaur	2582	Mechanic	392
7	Bunny Suit Guy	\$ 5.13	Jungle Boy	\$ 2.43	Evil Knight	983	Viking Woman	312
8	Santa	\$ 6.65	Cowgirl	\$ 2.93	DJ	512	Businessman	244
9	Forest Maiden	\$ 5.97	Alien Avenger	\$ 2.80	Heroic Knight	1164	Roller Derby Girl	301
10	Trendsetter	\$ 5.68	Baseball Fielder	\$ 2.80	Roman Commander	3610	Decorator	917
11	Scarecrow	\$ 5.04	Mountain Climber	\$ 3.08	Gingerbread Man	1126	Mountain Climber	267
TGB	Brawny Boxer	\$ 8.57	Agile Archer	\$ 5.97	Relay Runner	178	Judo Fighter	111

# Gender Comparison

Series	F	M	N
1	2	14	0
2	3	13	0
3	3	12	1
4	3	13	0
5	4	12	0
6	5	11	0
7	5	11	0
8	5	11	0
9	5	10	1
10	5	11	0
11	5	10	1
TGB	3	6	0
Toy Soldier	0	1	0
<b>TOTAL</b>	<b>48</b>	<b>136</b>	<b>3</b>

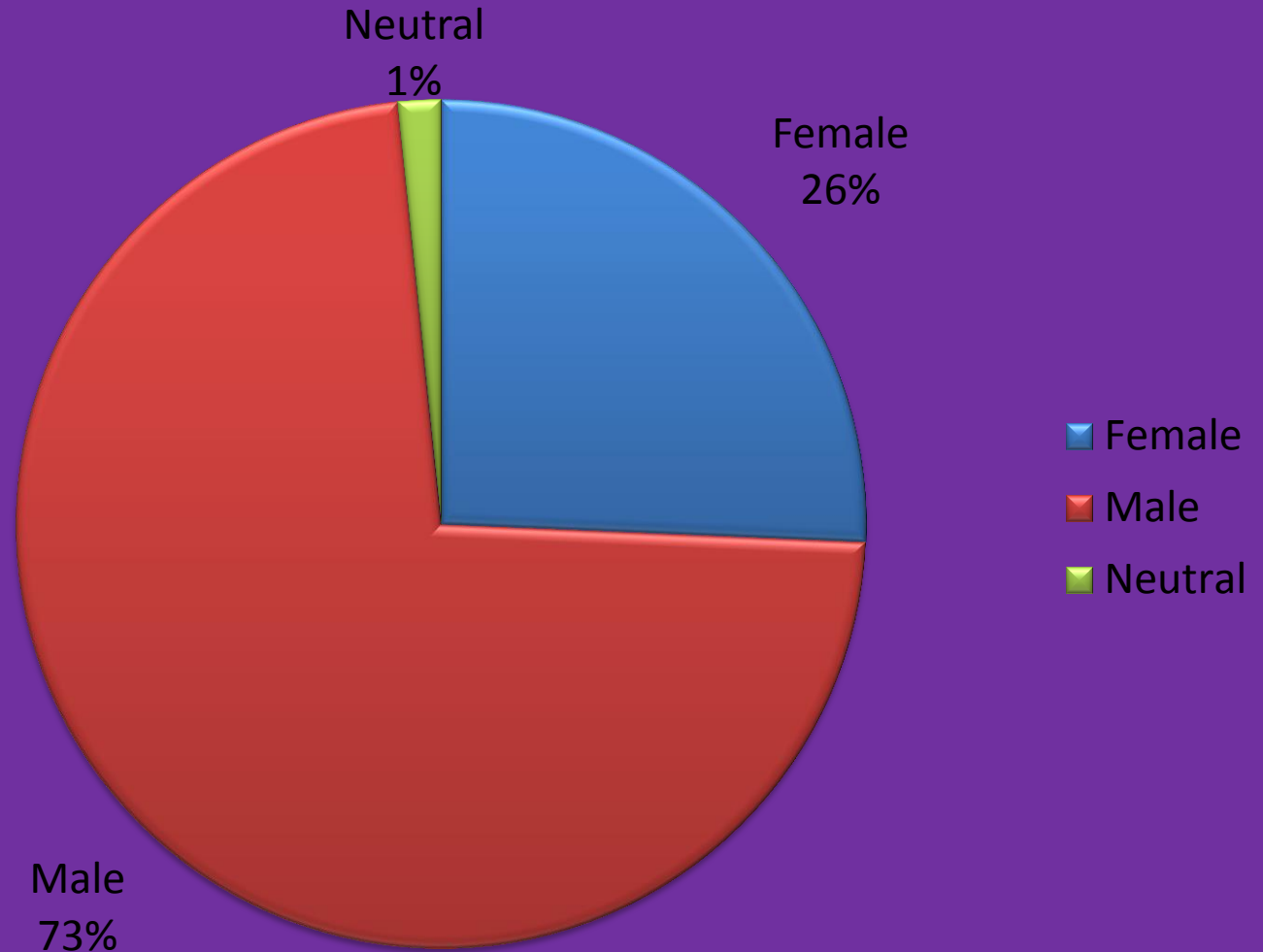



# Gender Comparison by Rarity

Rarity	F	M	N
Very Rare	11	9	0
Rare	16	37	0
Uncommon	17	47	2
Common	1	23	1
Very Common	0	12	0

Rarity	F	M	N
Very Rare	55%	45%	0%
Rare	30%	70%	0%
Uncommon	26%	71%	3%
Common	4%	92%	4%
Very Common	0%	100%	0%

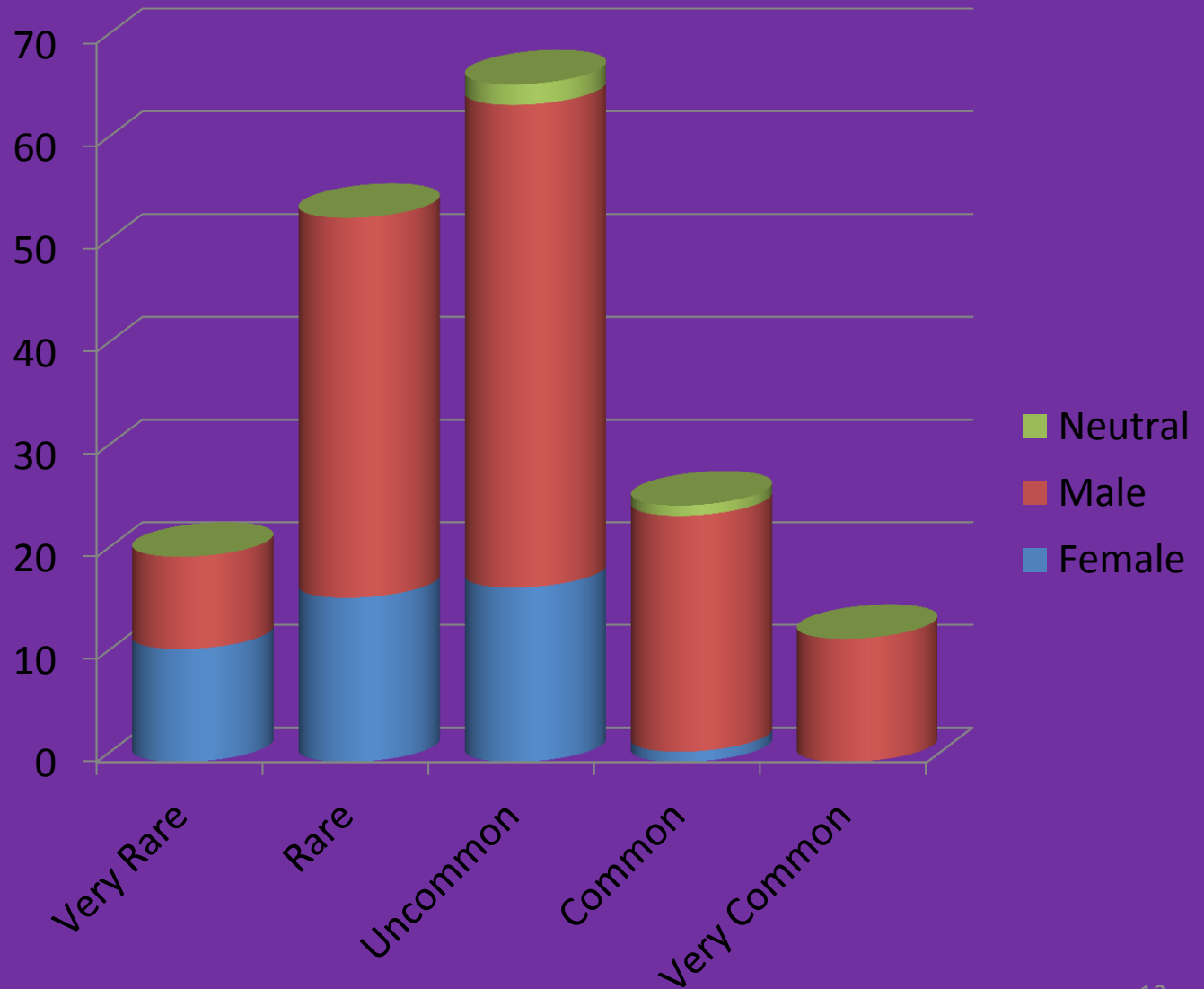

# Series 1 – May 2010

Avg price ea	Avg # of parts (not incl extras)	F count	M count	N count	# Sold last 6 mos	MVP Price Name	MVP Price
\$ 9.53	6.875	2	14	0	2927	Zombie	\$23.98

LVP Price Name	LVP price	MVP Qty Name	MVP Qty	LVP Qty Name	LVP qty	Avg Set Price	Avg Case Price
Deep Sea Diver	\$5.03	Demolition Dummy	385	Nurse	121	\$152.41	\$535.00



# Series 1 Stats

## Genders

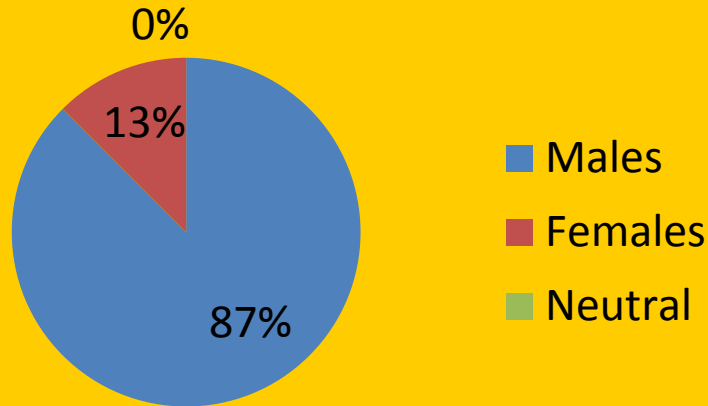

## Value

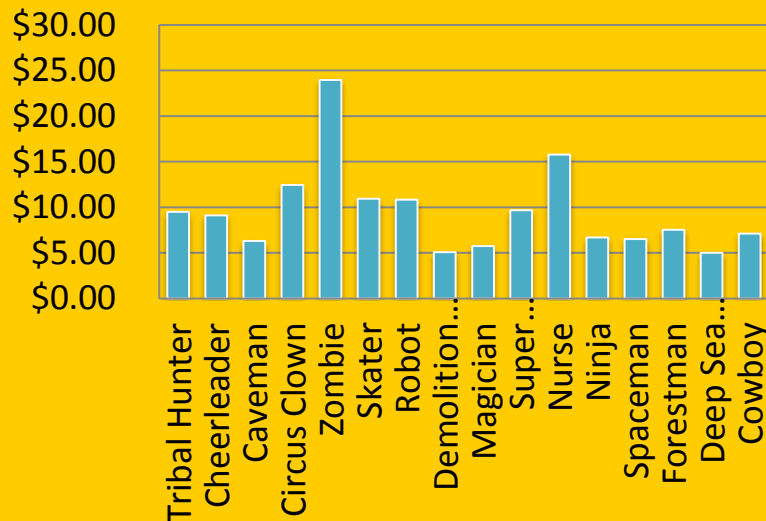

- Most Valuable = Zombie
- Most Popular = Demolition Dummy
- Least Valuable = Deep Sea Diver
- Least Popular = Nurse
- Average Set Value = \$152.41
- Average Figure Value = \$9.53
- Average # of Pieces = 6.875
- Rarest figures:
  - Tribal Hunter
  - Cheerleader
  - Circus Clown
  - Zombie
  - Skater
  - Super Wrestler
  - Nurse





Fan  
Favorite

# Cheerleader

Rare

“Gimmie an L! Gimmie an E! Gimmie a G! Gimmie an O! Yaaay!”

BL Code	# in box	Value	# of parts	# of extras	Face sides	Gender	# of sales	Strength	Creativity	Speed
col01-2	3	\$9.12	7	0	1	F	175	1	3	3

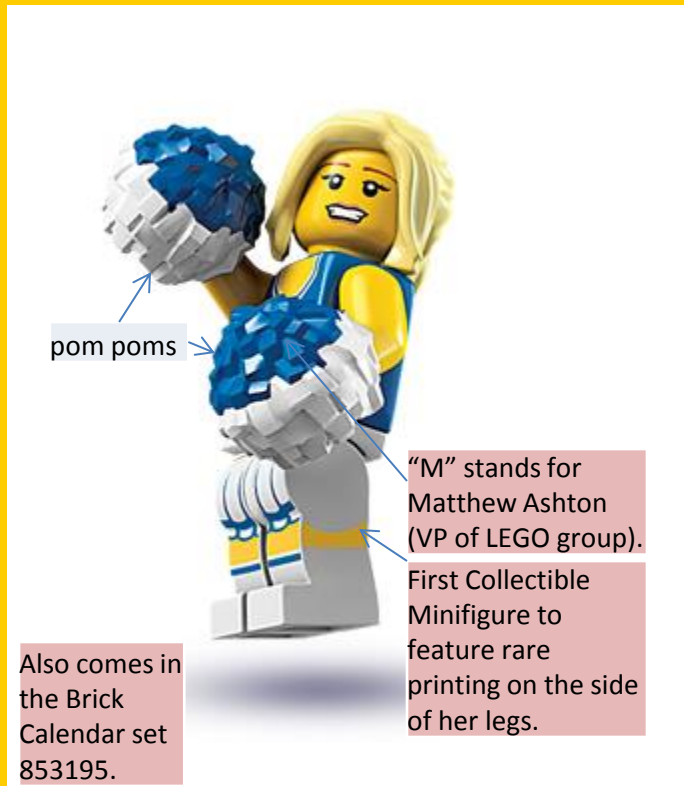

The Cheerleader is perpetually filled to bursting with energy, excitement and enthusiasm. She prefers cartwheels and handsprings to plain old ordinary walking, and she waves her pom-poms around wildly whenever she talks, which is pretty much all of the time.

The Cheerleader loves to cheer people on, no matter what they’re doing. Whether they’re changing a light bulb, building a wall or just crossing the street, she’s always there with a peppy cheerleading routine to encourage them to do their best and never give up. It can actually get kind of annoying sometimes, but her perpetual good mood and sunny smile are so contagious that it’s hard to really mind.

- The Cheerleader can cheer in nine different languages, including Spanish, French, ancient Latin and Esperanto.
- Banana splits with blueberry sauce are the Cheerleader’s favorite food in the whole world.
- The Cheerleader once did a hundred flips in a row...and boy, was she ever dizzy afterwards!

# Caveman

“Me build, therefore me am!”

BL Code	# in box	Value	# of parts	# of extras	Face sides	Gender	# of sales	Strength	Creativity	Speed
col01-3	4	\$6.30	6	0	1	M	206	4	1	4

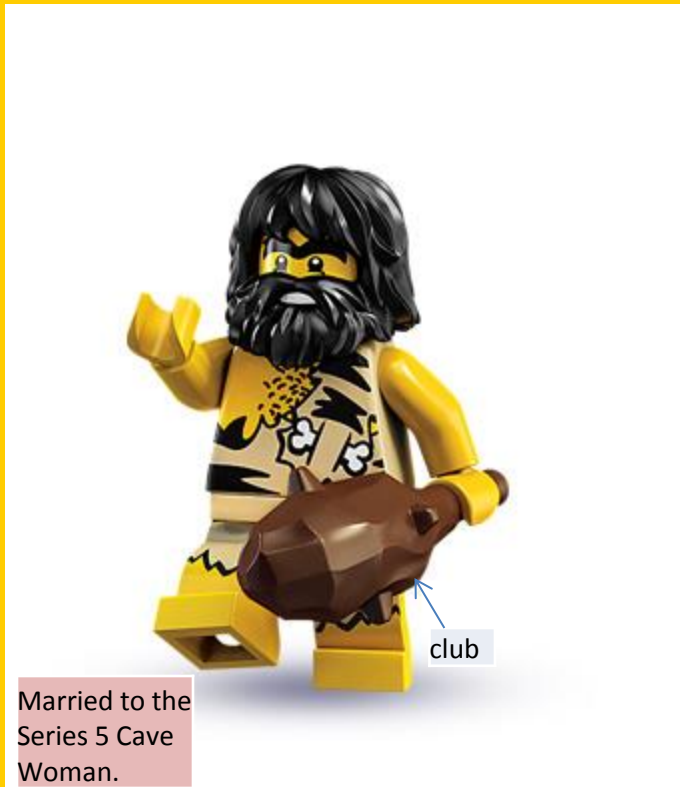

This would-be inventor from the prehistoric past is always tinkering with sticks, rocks and the occasional bricks he finds lying around, trying to invent something new. Of course, everything he comes up with has already been invented – he’s a Caveman with a tiny little brain, after all – but that doesn’t stop him from trying. He never gets jokes and usually needs things explained to him with gestures and pictures...and even then, he gets it wrong most of the time.

The Caveman is very strong and always hungry. If something looks like it might be food, he’ll try to take a bite, and if it runs away, he’ll lift his club up above his head and chase it down. Not a lot of people know it, but he’s also an excellent artist who can create incredible landscapes and murals using only the simplest of tools!

- The Caveman has a pet woolly mammoth named Henry.
- The Caveman’s proudest accomplishment was inventing the wheel. He was very sad when he found out someone else did it first.
- The Caveman sometimes falls asleep at the natural history museum and wakes up on display.

# Circus Clown

Rare

“Honk honk!”

BL Code	# in box	Value	# of parts	# of extras	Face sides	Gender	# of sales	Strength	Creativity	Speed
col01-4	3	\$12.44	6	0	1	M	127	3	3	5



Everything in life is a joke to the mirthful, merry and mischievous Circus Clown. Whenever things get too dull, up he pops with a banana cream pie to toss, a bottle of seltzer to spray, or a honk of his horn to brighten your day. You can always count on him to appear with a funny gag at just the right moment to lighten the mood.

The Circus Clown is a master of physical comedy, and it's a good thing, too – aside from a honk of his horn or his big red nose, he never makes a sound, even when doubled-over with laughter at his own silly antics!

- The Circus Clown can communicate with geese by honking his horn.
- Because most Minifigures don't have noses, very few people know what that red thing in the middle of the Circus Clown's face is.
- The Circus Clown grows his own water-squirting plastic flowers in a little garden at home.

# Zombie

“Briiiiiiiiiicks...”



BL Code	# in box	Value	# of parts	# of extras	Face sides	Gender	# of sales	Strength	Creativity	Speed
col01-5	3	\$23.98	6	0	1	M	130	3	1	2

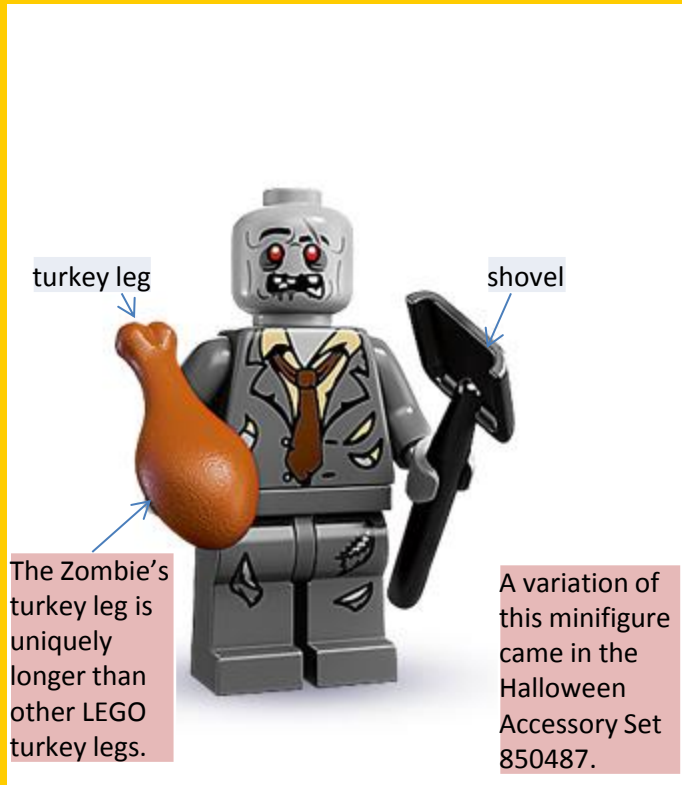

Slow in speed and even slower of mind, the lumbering Zombie may look a little scary, but he's completely harmless in every way. Everything he does is slow, mindless and repetitive, from zoning out while watching TV, to waiting in line at the grocery store, to stacking one brick on top of another to build a perfectly even, completely featureless wall that stretches along for miles and miles.

If you interrupt him, he'll just stare at you blankly before going back to whatever he was doing before. If you put an obstacle in front of him, he'll keep bumping into it over and over again until someone turns him around. If you pick him up and move him to a new place, he'll start doing something mindless there instead. The only thing that seems to motivate him is his cherished turkey leg – if you dangle it in front of him, he'll stretch his arms out toward it and follow it wherever it goes.

- The only thing that the Zombie is afraid of is ordinary table salt. It terrifies him!
- The Zombie has watched so much TV that he has become a master of trivia...but nobody ever asks him to share any of it.
- The Zombie loves Halloween. Nobody runs away from him, and everyone thinks he has the best costume.



# Skater

Rare

“Bet you can’t do THIS!”

BL Code	# in box	Value	# of parts	# of extras	Face sides	Gender	# of sales	Strength	Creativity	Speed
col01-6	3	\$10.95	8	0	1	M	139	2	3	5



The young Skater practices all the time to be the greatest skateboarder in the world. He lives for speed and tricky stunts, and when he’s around, any and every surface becomes his own private skate park. His board is his prize possession, and he always makes sure to keep it clean and shiny, even when he gets totally grungy himself.

The Skater is extremely competitive, and he can’t stand to see anyone do something better or faster than he does. His rivalry isn’t just limited to other skateboarders – he’ll try to out-race trains and out-jump pigeons flying in the park, just to prove he can. He hasn’t beaten them yet, but he’s sure he will some day!

- The Skater hopes to someday find a way to beat his toughest opponent: himself! (He thinks time travel might work.)
- The Skater’s most terrible secret is that he can’t ride a bicycle without falling off.
- The Skater’s ultimate dream is to star in his own LEGO Island video game. · The Skater went to the hospital 12 times from car accidents.

# Robot

“Not building does not compute!”

BL Code	# in box	Value	# of parts	# of extras	Face sides	Gender	# of sales	Strength	Creativity	Speed
col01-7	4	\$10.85	6	1	1	M	132	5	5	3

Had the name **Axon Klaxon** in LEGO Universe.

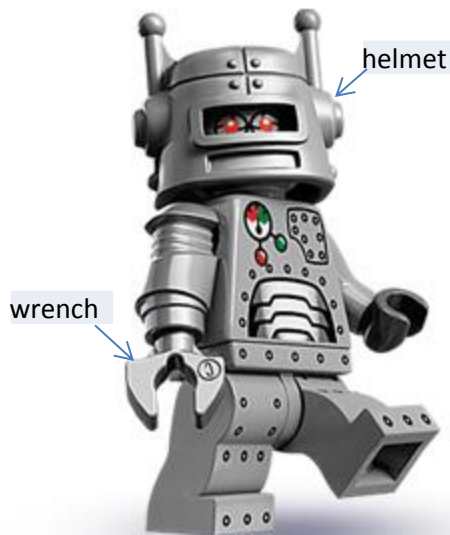

With his powerful metal body and mighty claws, the Robot may look tough, but what he really loves to do is build, build, build! Constantly clanking, beeping, whirring and sending out jets of steam, he works tirelessly day and night, searching out spare bricks wherever he can find them and stacking them together to create the biggest, tallest and most incredible structures that you can possibly imagine. In fact, he loves constructing things so much that sometimes he forgets to recharge his circuits and freezes in place, right in the middle of building.

He's slow to react to things that he doesn't expect, and prone to occasional short-circuits, with a tendency to walk right into holes, spin around suddenly in place or crash through walls without even noticing. He also has a bad habit of "finding" bricks in other people's creations and marching off with them, right over or through any obstacles in his way, but don't blame the Robot – it's just his programming!

- The Robot once crossed an entire ocean by walking along the sea floor. The **Deep Sea Diver** was pretty surprised to see him there!
- The Robot's internal parts include three tin cans, string from a kite, a coat hanger, a wind-up music box, and an old tea kettle.
- Nobody knows who originally built the Robot years and years ago. Even the Robot himself doesn't remember.

# Demolition Dummy

“Disassemble! Demolish! Deconstruct!”

MVP  
Qty

BL Code	# in box	Value	# of parts	# of extras	Face sides	Gender	# of sales	Strength	Creativity	Speed
col01-8	5	\$5.10	6	0	1	M	385	5	1	3



The Demolition Dummy exists to take things apart. He is compelled to disassemble everything that he comes across into its component parts, leaving piles of pieces behind wherever he goes. Although he doesn't seem to be very bright or creative, he is extremely persistent, and it's difficult to stop him once he starts trying to deconstruct something. No matter what anyone else does, he always seems to find a way to accomplish his task.

Having the Demolition Dummy and the **Robot** in the same place together is like watching a perpetual motion machine – one constantly builds while the other un-builds, over and over again. No one really knows what motivates the Demolition Dummy to take everything he sees apart, but he certainly seems happy about it when he's done...until he spots the next thing to disassemble, and then off he goes!

- The Demolition Dummy got his driver's license on his first try.
- Sometimes when he's bored, the Demolition Dummy takes himself apart and waits for someone to come put him back together.
- The Demolition Dummy is terrible at jigsaw puzzles...but he's great at bowling!

# Magician

“Hey presto, allez-ooop – and it’s gone!”

BL Code	# in box	Value	# of parts	# of extras	Face sides	Gender	# of sales	Strength	Creativity	Speed
col01-9	4	\$5.74	7	0	1	M	281	1	5	2



Appearing out of nowhere with a flourish of his cape and a twirl of his elegant, curly moustache, the mysterious Magician is the ultimate in stylish showmanship. He loves a good audience to appreciate his incredible and sense-defying magic tricks, but watch out – not only is he an amazing performer, but he’s also a talented prankster as well! He’ll confuse, bewilder and amaze with a mix of sleight-of-hand and impossible feats, and the more surprised his audience is, the better.

Whether he’s making a flock of doves fly out of his wand or pulling a giant rabbit out of his magic hat, the Magician is always ready to put on a spectacular show...right up until he vanishes without a trace in a flash of lightning and a puff of smoke!

- The Magician enjoys playing miniature golf in his time off, but he usually cheats.
- One time, the Magician’s hypnosis act backfired and he spent two weeks thinking he was a giant chicken.
- The Magician’s trained rabbits are specially bred in a remote monastery high in the hidden mountains of Timbuktu.

# Super Wrestler

Rare

“I will defeat you – with HONOR!”

BL Code	# in box	Value	# of parts	# of extras	Face sides	Gender	# of sales	Strength	Creativity	Speed
col01-10	3	\$9.69	5	0	1	M	145	5	1	3



Only three things matter to the Super Wrestler: his mask, his honor, and the time-honored art of wrestling. He throws himself at every challenge that comes his way with gusto, counting on the strength of justice and his muscular arms to save the day, no matter the odds or danger. When victory is his, he throws out his arms to the sound of roaring cheers and wild applause...which is a little odd when there doesn't seem to be anyone else around.

There are few situations that the Super Wrestler doesn't think can be solved with a bold battle cry and a fancy wrestling move. The surprising thing isn't that he treats life like it's all a big wrestling match – it's that so far, it's always worked!

- The Super Wrestler irons his cape every night. · The Super Wrestler would be willing to accept a wrestling challenge from the **Lizard Man**.
- The Super Wrestler once out-wrestled an octopus to save a bus full of kittens.
- The Super Wrestler inherited his mask from his father, who got it from his grandfather, who made it at school.

# Nurse

Rare

“Don’t worry, you’ll feel all better after this!”

BL Code	# in box	Value	# of parts	# of extras	Face sides	Gender	# of sales	Strength	Creativity	Speed
col01-11	3	\$15.79	7	1	1	F	121	3	2	3

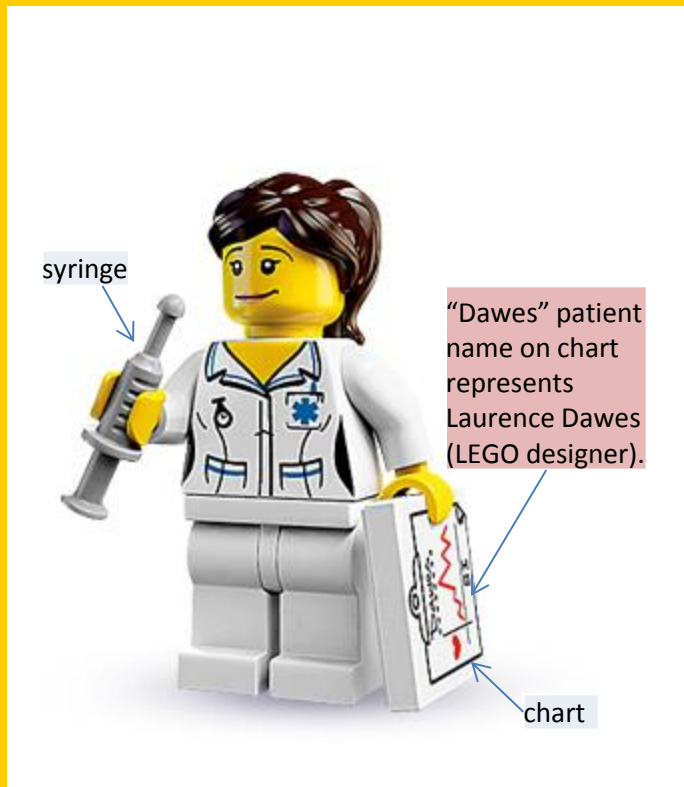

Cheerful, professional and devoted to making people feel better, the Nurse believes that everybody around her ought to be as healthy as possible at all times, even if that means covering them from head to toe in bandages and checking every reflex in their body with a little rubber hammer. She can tape up a boo-boo, dash to the scene of an accident with a wheelchair or build a fully-functional MRI machine out of random spare pieces, all in a dizzying blur of motion...whether her chosen patient wants her to or not!

The Nurse thinks that every problem can be solved by expert medical care. If she sees a child crying because its balloon is stuck up in a tree, she'll try everything from checking its temperature to taking X-rays, trying more and more complicated procedures when nothing seems to solve the problem. She doesn't understand why the tears stop as soon as she gives the child a new balloon for being such a good patient, but she's proud and delighted that her treatment worked anyway.

- The Nurse once came up with a cure for the common cold, but she got distracted treating a patient and forgot what it was.
- The Nurse knows 48 different recipes for chicken soup.
- The Nurse once treated an entire school for nose lice before she found out they didn't really exist.



# Ninja

“Like a shadow in the night, I – oops!”

BL Code	# in box	Value	# of parts	# of extras	Face sides	Gender	# of sales	Strength	Creativity	Speed
col01-12	5	\$6.70	6	1	1	M	201	4	3	4



Stealthy. Sneaky. A cunning master of martial arts. None of these things describes the Ninja, although he sure wishes they did. He tries his best to dramatically blend into the shadows or hide in plain sight like all the other ninjas can, but no matter what he does, he always seems to mess things up. The truth is that he’s just plain clumsy, and no matter how gracefully he may start a back-flip, creep along the rafters or launch himself into an epic sword battle, he always manages to trip over his own feet, fall off the ceiling, or bonk himself on the head with his ancient and mystical blade. Also, he’s afraid of the dark.

No one is quite sure how the Ninja ever managed to graduate from ninja school. But no matter how bad he may be at his chosen profession, he always keeps trying and never gives up, convinced after each blunder that the next time, he will prove himself a true ninja warrior for the ages.

- The Ninja was discovered as a baby on the doorstep of his clan’s temple, with a note that said “Please make me a ninja!”
- The Ninja failed his final ninja exams a record 123 times.
- The Ninja’s sword has magical powers, but all he knows how to do with it is make really good ham and cheese sandwiches.

# Spaceman

“Greetings, strange creatures. I come in peace!”

BL Code	# in box	Value	# of parts	# of extras	Face sides	Gender	# of sales	Strength	Creativity	Speed
col01-13	4	\$6.54	8	1	1	M	183	2	2	1

Had the name **Ace Warprider** in LEGO Universe.



This brave and intrepid space traveler doesn't quite realize that he's not out exploring the cosmos. The Spaceman walks in long, slow bounds across the landscape, somehow ignoring the fact that gravity is perfectly normal for everything else around him. He's friendly and fearless, always happy to investigate a strange new place or salute a stranger with a universal-greeting hand gesture, but his unshakeable belief that he's dealing with alien creatures and worlds can lead to a lot of confusion for everyone involved.

The Spaceman carries a sci-fi gizmo for just about any situation, including hi-tech binoculars, a grappling hook, a jetpack and even a tiny, remote-controlled space rover. Just be careful if you startle him into thinking that you're an attacking hostile alien – his futuristic Electro-Zapp blaster fires a zig-zagging electric beam that can zap the hair right off a minifigure!

- The Spaceman always carries a book of useful alien phrases. You never know when you'll need to order lunch in Venusian!
- The Spaceman sleeps in a special bunk bed with magnetic straps to keep him from floating away during the night. He hates that!
- The Spaceman came here from the future. He travelled back in time thanks to an accident involving a runaway comet and a black hole.

# Forestman

“Have no fear, for I am here!”

BL Code	# in box	Value	# of parts	# of extras	Face sides	Gender	# of sales	Strength	Creativity	Speed
col01-14	4	\$7.56	8	1	1	M	155	3	3	3



The brave and fearless Forestman is always arriving just in the nick of time to save the day. Whether he’s swinging down on a vine to rescue a damsel in distress, leaping boldly from the castle battlements to duel an evil duke, or making an incredible trick shot with his bow and arrow to help a friend in danger, he is at all times the very model of a chivalrous hero of legend and yore.

The Forestman loves to make a good first impression and is always practicing his dramatic entrances to get them just right. He’d come to the rescue anyway, of course (it’s just in his nature to right wrongs and fight injustice wherever he finds them), but it’s terribly disappointing for him if no one is around to see him gallantly arrive on the scene for his latest feat of swashbuckling derring-do. He’s only sad for a moment, though, and then it’s off to battle the bad guys and save the day once again!

- The Forestman once rescued two princesses, saved three villages from evil trolls, and defeated an entire band of pirates in one day. Before breakfast.
- The Forestman has a lifelong fear of crocodiles.
- Despite years of living in the woods, the Forestman still can’t tell poison ivy from the regular kind.

# Deep Sea Diver

“Blub blurb glub?”

BL Code	# in box	Value	# of parts	# of extras	Face sides	Gender	# of sales	Strength	Creativity	Speed
col01-15	5	\$5.03	9	0	1	M	219	3	3	3



The Deep Sea Diver seems like a nice enough fellow, but no one can tell for sure, because no one can understand what he’s saying. Whenever he speaks, all that comes out is burbles and bubbles. He might be easier to understand if he ever took off his diving mask and air tank, but he thinks that he can’t breathe without them and always keeps them on, even when he’s walking around on land – which is a pretty funny sight, thanks to those big flippers on his feet!

The Deep Sea Diver loves the water and can often be found swimming around in fish tanks and bathtubs, hoping to spot rare and exotic fish. He loves to tell stories about his amazing undersea adventures, but of course it’s impossible to guess what he’s actually talking about. His gestures and sound effects certainly make it all sound very exciting, though!

- The Deep Sea Diver spent a week in Atlantis, but nobody back home could understand him when he tried to tell them about it.
- The Deep Sea Diver has personally discovered over thirty new species of sea life, including the Chocolate-Chip Cookie Shark and the Inflatable Squid.
- The Deep Sea Diver once traveled twenty-ONE thousand leagues under the sea.

# Cowboy

“Yee-haw and yippie-ki-yay!”

BL Code	# in box	Value	# of parts	# of extras	Face sides	Gender	# of sales	Strength	Creativity	Speed
col01-16	4	\$7.12	7	1	1	M	195	2	3	2



This hero of the Old West is a master of the lucky shot. With the help of his trusty pair of six-irons, the Cowboy can hit any target at any distance, no matter how large or small. It's a talent that he's used to get himself out of plenty of sticky situations, and he's happy to show it to anyone who asks for a demonstration.

Though he's a bit of a show-off, the Cowboy is impeccably honest and fair, and always raises his hat to the ladies. He enjoys a good game of cards and a campfire cook-out, especially if someone's brought along his favorite: chocolate, marshmallows and graham crackers. He never stays for long in any town, though, because he's always out on the trail looking for his lost horse. After all, who's ever heard of a cowboy without a horse?

- The Cowboy can lasso a fly right out of the air, but he never knows what to do with one after he's caught it.
- The Cowboy likes to go on vacation to the big city, where he finds all of the noise, crowds and traffic very relaxing.
- While some kids go to camp, the Cowboy was sent to live with wild coyotes every summer instead.



# Series 2 – September 2010

Avg price ea	Avg # of parts (not incl extras)	F count	M count	N count	# Sold last 6 mos	MVP Price Name	MVP Price
\$ 5.24	6.8125	3	13	0	6123	Spartan Warrior	\$14.47

LVP Price Name	LVP price	MVP Qty Name	MVP Qty	LVP Qty Name	LVP qty	Avg Set Price	Avg Case Price
Ringmaster	\$ 2.74	Karate Master	992	Skier	139	\$ 83.85	\$295.68





# Series 2 Stats

## Genders

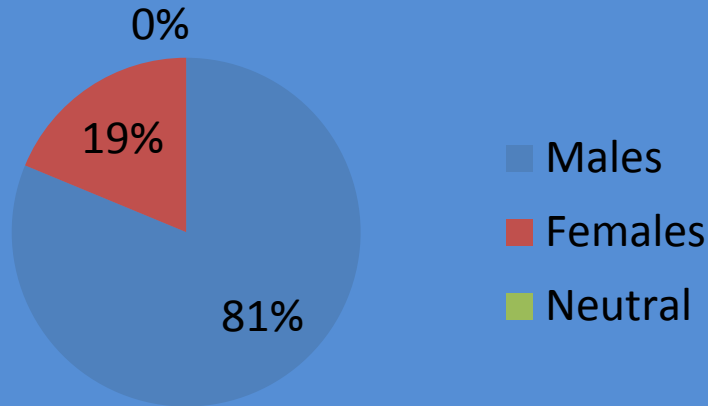

## Value

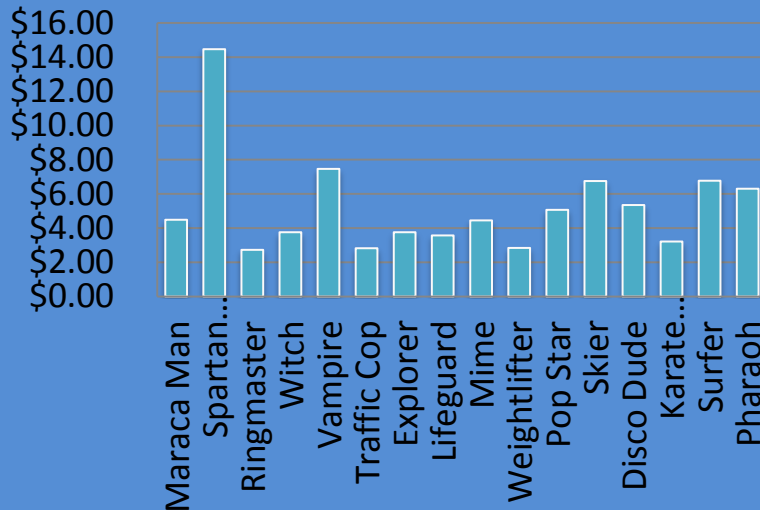

- Most Valuable = Spartan Warrior
- Most Popular = Karate Master
- Least Valuable = Ringmaster
- Least Popular = Skier
- Average Set Value = \$83.85
- Average Figure Value = \$5.24
- Average # of Pieces = 6.8125
- Rarest figures:
  - Spartan Warrior
  - Explorer
  - Pop Star
  - Skier
  - Disco Dude
  - Surfer
  - Pharaoh

# Maraca Man

“Hear the music of the maracas!”

BL Code	# in box	Value	# of parts	# of extras	Face sides	Gender	# of sales	Strength	Creativity	Speed
col02-1	4	\$4.50	8	1	1	M	597	2	5	2



Can you hear that? It may be hard to hear at first, but keep listening and soon you'll hear the sound of a pair of bright red maracas rattling out a fun and festive tune. That's how everybody knows that the Maraca Man is on his way!

When the Maraca Man dances through the street shaking his maracas, everyone around him finds themselves cheering up. Where he comes from is a mystery and where he'll go next is too, but whenever he's near, people smile, clap, and tap their feet to the beat!

Fan  
Favorite

# Spartan Warrior

MVP  
Price

Rare

“For Sparta!”

BL Code	# in box	Value	# of parts	# of extras	Face sides	Gender	# of sales	Strength	Creativity	Speed
col02-2	3	\$14.47	8	0	1	M	259	5	2	4

Had the name  
**Achilles Plutarch** in  
LEGO Universe.



The Spartan Warrior's favorite thing in the world to do is fight. He keeps his spear, shield and crested helmet polished and clean at all times, just waiting for the next big battle to start. The problem is that there really isn't much of a call for ancient Spartan soldiers these days, so he mostly sits around and watches historical documentaries on TV.

Since he doesn't get to do much fighting, the Spartan Warrior tries all sorts of things to keep himself in fighting shape. He goes jogging every morning, swims at the pool in the afternoon, and even takes dancing classes at the nearby school to make sure he stays fit and trim for the next big battle!

# Ringmaster

“Ladies, gentlemen and children of all ages, you will not believe your eyes!”

BL Code	# in box	Value	# of parts	# of extras	Face sides	Gender	# of sales	Strength	Creativity	Speed
col02-3	5	\$2.74	6	0	1	M	551	3	3	3



The Ringmaster loves being in the spotlight and running the show. He's in charge of the entire circus, and he always makes sure to keep the tightropes tight, the sawdust fresh, the trapeze rings shiny and all the animals fed and happy.

To the Ringmaster, the best thing in the entire world is the sound of the audience cheering and clapping all around the big-top circus tent. That's why he always does his very best to put on the most spectacular show possible – and to outdo the performance from the night before!



# Witch

“Am I a good witch or a bad witch?”

BL Code	# in box	Value	# of parts	# of extras	Face sides	Gender	# of sales	Strength	Creativity	Speed
col02-4	4	\$3.76	6	0	1	F	719	4	2	4



Had the name **Olivia Nightshade** in LEGO Universe.

The Witch is a misunderstood person. She just wants to be good, but with all the magic power she has, there are times when she just can't help being a little bit bad.

For every bad thing the Witch does, she tries to do something good...but it doesn't always go exactly like she plans. For example, turning the vegetables growing in her neighbor's garden into candy sounded like a good idea at the time. All of the children in town were happy about it, but her neighbor seemed really mad for some reason!

# Vampire

“I’m supposed to drink WHAT?!”

BL Code	# in box	Value	# of parts	# of extras	Face sides	Gender	# of sales	Strength	Creativity	Speed
col02-5	4	\$7.46	7	0	1	M	251	5	3	5

Had the name **Rutger Hemoglobin** in LEGO Universe.



The Vampire may be a 200-year-old creature of nightmare and legend, but that doesn't mean that he has to be uncivilized. He likes to read comic books with his pet bat, take long walks by the seaside (after sunset, of course), and throw huge parties in his big stone castle.

He's not a big fan of the more traditional vampire activities (though he has to admit that the flying is pretty cool), and much prefers a fruit smoothie to the classic beverage of choice. The local villagers might have been a little spooked at first, but now they're very excited to have a friendly vampire in town!

# Traffic Cop

“Mine are the safest streets in town!”

BL Code	# in box	Value	# of parts	# of extras	Face sides	Gender	# of sales	Strength	Creativity	Speed
col02-6	5	\$2.82	7	1	1	M	528	3	3	3



The Traffic Cop patrols the streets, looking for anybody who's speeding or up to no good on the roads and highways. Don't try to break the law in his city, because he's sure to find you and give you a ticket!

The Traffic Cop doesn't want to seem mean, but he knows how important it is to enforce the rules and keep the city safe. After all, protecting the people who live there is a huge responsibility!

# Explorer

Rare

“By Jove, I do believe I’ve found something new!”

BL Code	# in box	Value	# of parts	# of extras	Face sides	Gender	# of sales	Strength	Creativity	Speed
col02-7	3	\$3.76	7	1	1	M	315	2	4	2

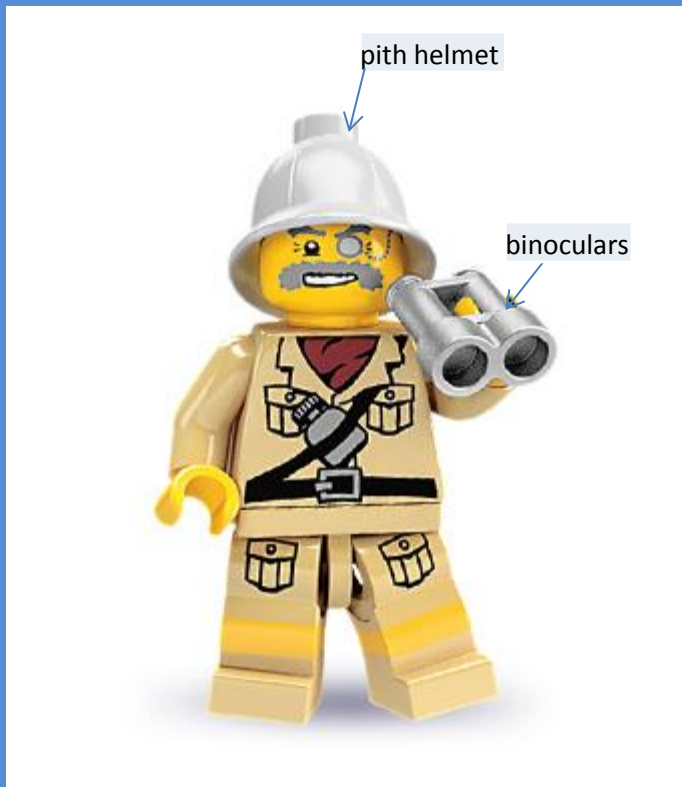

The Explorer travels all over the world in search of new places, animals and plants to discover and study. The more exotic and difficult something is to find, the better as far as he’s concerned!

Whenever he finds something unusual, he makes sure to draw it and write it down in his explorer’s journal, which he’s secretly hoping to turn into a best-selling book some day. The world is just full of exciting new surprises when you’re an Explorer!



# Lifeguard

“Just yell ‘help’ and I’m on my way!”

BL Code	# in box	Value	# of parts	# of extras	Face sides	Gender	# of sales	Strength	Creativity	Speed
col02-8	4	\$3.57	6	0	1	F	326	2	3	5



The Lifeguard is trained in all of the latest life saving techniques and knows how to use each and every piece of rescue equipment at the beach. She sits in her high chair, keeping a careful eye on the ocean so that everyone who puts even a toe in the water is safe.

Helping people is the Lifeguard's passion, and when she's not lifeguarding, she's in medical school studying to be a doctor. She wants to make sure that no one ever gets hurt on her watch. Even the sharks feel safe when she's around!

# Mime

“ ”

BL Code	# in box	Value	# of parts	# of extras	Face sides	Gender	# of sales	Strength	Creativity	Speed
col02-9	4	\$4.46	7	0	1	M	305	1	5	2



If you've ever been sure that somebody was silently following you and making silly faces, but nobody was there when you turned around, it was probably the Mime. He shows up in public parks, outside restaurants and in market squares, where he performs routines and does impressions of passers-by without ever making a sound.

No one pretends to be trapped in an invisible box or walking against the wind as well as the Mime does. His best pal is the **Circus Clown**, and the two frequently join forces to get even bigger laughs and applause from their audience!

# Weightlifter

“299...300...301...”

BL Code	# in box	Value	# of parts	# of extras	Face sides	Gender	# of sales	Strength	Creativity	Speed
col02-10	4	\$2.84	8	0	1	M	411	5	2	2



The Weightlifter has sworn to become the strongest man in the entire world. He runs around the city looking for things to pick up...and he wants to pick up EVERYTHING. As long as an object isn't nailed to the ground, he'll scoop it up and try to lift it over his head. The only thing that the Weightlifter pays attention to is how heavy something is. If it weighs more than the last thing he lifted, then it's just what he needs, whether it's a person, an auto, an elephant or a house. No challenge is too big for the Weight Lifter!

# Pop Star

Rare

“This one goes out to all my fans!”

BL Code	# in box	Value	# of parts	# of extras	Face sides	Gender	# of sales	Strength	Creativity	Speed
col02-11	3	\$5.07	6	1	1	F	144	1	4	3



Had the name **Gwen Tweenbangle** in LEGO Universe.

microphone

Created in honor of then-Creative Director Matthew Ashton's love of pop music.

The Pop Star is at the top of the charts. Her last three albums went platinum and her videos are in non-stop rotation on all the music channels. She travels the world in limos and private jets and has more fans than she knows what to do with. No matter how famous she gets, though, the Pop Star is still a normal girl who dances around her bedroom singing to the mirror, likes to hang out with her friends at the movies, and loves a good burger and fries!

# Skier

Rare

“I’m going to make it this time!”

BL Code	# in box	Value	# of parts	# of extras	Face sides	Gender	# of sales	Strength	Creativity	Speed
col02-12	3	\$6.75	9	0	1	M	139	3	3	4



The enthusiastic Skier is constantly plunging off cliffs, crashing into trees, and performing accidental loop-the-loops through the air. He can't help tackling any new downhill challenge that he comes across, even if his attempts don't always end so well!

What everybody likes about the Skier is that he never, ever gives up. No matter how many times his skiing feats end in wild disaster, he always climbs right back up the mountain, straps on his skis, and tries his luck one more time. After all, the fifteenth time might just be the charm!



# Disco Dude

Rare

“Hey, everybody! Let’s Disco!”

BL Code	# in box	Value	# of parts	# of extras	Face sides	Gender	# of sales	Strength	Creativity	Speed
col02-13	3	\$5.36	6	0	1	M	194	3	5	4



Had the name **Barry Smoothmoves** in LEGO Universe.

The Disco Dude has traveled back in time to relive the days of disco dancing, bell-bottom pants and the very first LEGO Space sets. He can't help but love it! Whenever he hears a disco beat and sees the big disco ball lights start flashing, he gets caught up in the music and just can't stop dancing.

And what's more, it's his love of disco is contagious! Wherever the Disco Dude starts dancing, everybody around him can't help but join in on the fun. Pretty soon, it's all one big '70s disco dance party!

# Karate Master

MVP  
Qty

“Whatever it is, I can chop it in half!”

BL Code	# in box	Value	# of parts	# of extras	Face sides	Gender	# of sales	Strength	Creativity	Speed
col02-14	5	\$3.21	6	1	1	M	992	5	3	5



The Karate Master is ready to take on any challenge. His martial arts training is the most important thing to him, and even though he's already a master, he's always practicing more to make himself even better.

Since he earned his black belt, the Karate Master has devoted his efforts to teaching others to reach their own maximum skill levels – not just at karate, but at everything else that interests them, too. With so many trophies on his shelves, it's no wonder everyone wants to learn from him!

# Surfer

Rare

“G’day, dudes and dudettes!”

BL Code	# in box	Value	# of parts	# of extras	Face sides	Gender	# of sales	Strength	Creativity	Speed
col02-15	3	\$6.78	6	0	1	M	171	3	2	4

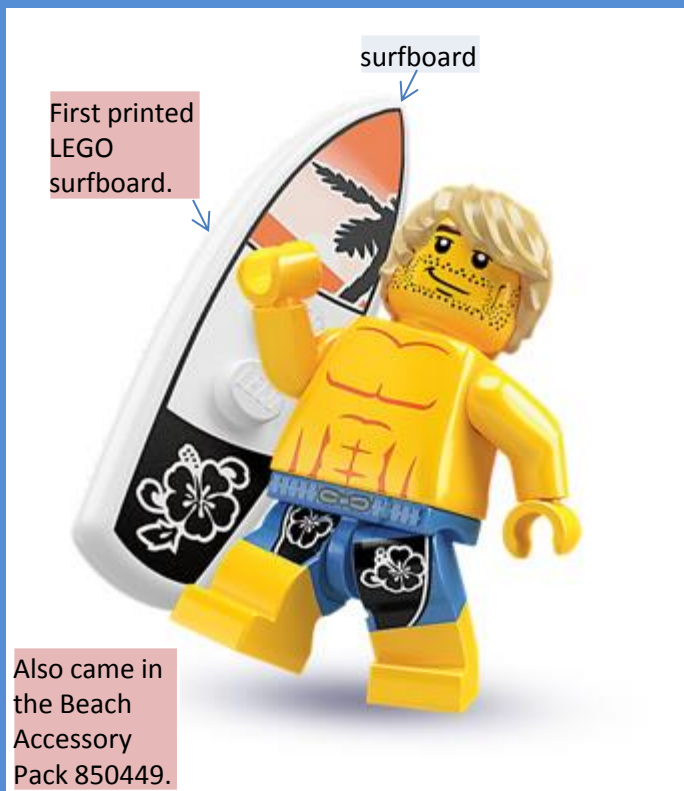

Wherever the waves are radical and the surf is bodacious, that’s where you’ll find the Surfer. He’s the most relaxed guy around, but as soon as it’s time to hop on his surfboard, nothing can keep him from hanging ten from sunrise until sunset!

The Surfer has traveled all over the world and surfed at every beach he can find. No matter where he goes, he’s always sure to find a fun challenge on the rolling, splashing ocean!

# Pharaoh

Rare

“That spot looks just right for a pyramid!”

BL Code	# in box	Value	# of parts	# of extras	Face sides	Gender	# of sales	Strength	Creativity	Speed
col02-16	3	\$6.30	6	0	1	M	221	4	2	2



This Pharaoh of ancient Egypt woke up in a museum one day, and he's been a little confused ever since. He doesn't know how or why he's in the modern world, but it's definitely taking some getting used to! He's not used to taxi cabs and supermarkets yet, and he can't figure out where all the sphinxes and crocodiles have gone, but he's trying to make the best of things in his strange new circumstances.

First off, the place is definitely going to need some pyramids...so with the help of his friends at the museum, the Pharaoh is taking matters into his own hands and using all the bricks he can find to build his own. Now he has a little piece of home to share with everyone!

# Series 3 – January 2011

Avg price ea	Avg # of parts (not incl extras)	F count	M count	N count	# Sold last 6 mos	MVP Price Name	MVP Price
\$ 3.85	6.875	3	12	1	6087	Elf	\$8.23

LVP Price Name	LVP price	MVP Qty Name	MVP Qty	LVP Qty Name	LVP qty	Avg Set Price	Avg Case Price
Race Car Driver	\$ 2.42	Karate Master	992	Space Villain	216	\$ 61.53	\$220.11





# Series 3 Stats

## Genders

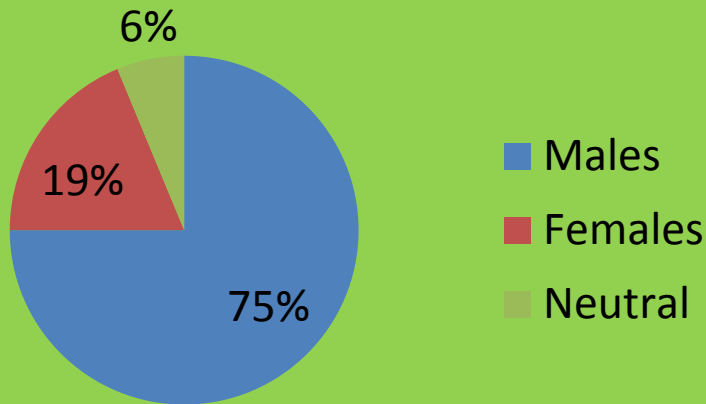

## Value

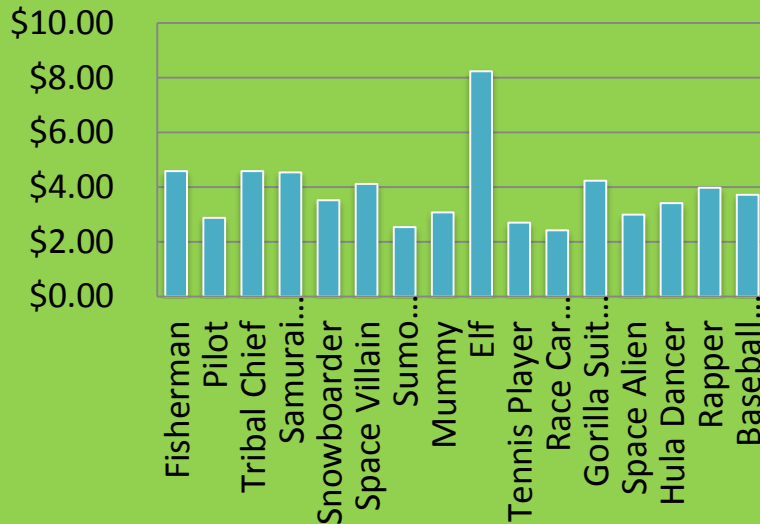

- Most Valuable = Elf
- Most Popular = Karate Master
- Least Valuable = Race Car Driver
- Least Popular = Space Villain
- Average Set Value = \$61.53
- Average Figure Value = \$3.85
- Average # of Pieces = 6.875
- Rarest figures:
  - Fisherman
  - Tribal Chief
  - Snowboarder
  - Space Villain
  - Elf
  - Hula Dancer
  - Rapper

# Fisherman

Very  
Rare

“That reminds me of the time...”

BL Code	# in box	Value	# of parts	# of extras	Face sides	Gender	# of sales	Strength	Creativity	Speed
col03-1	2*	\$4.59	9	0	1	M	279	2	2	2

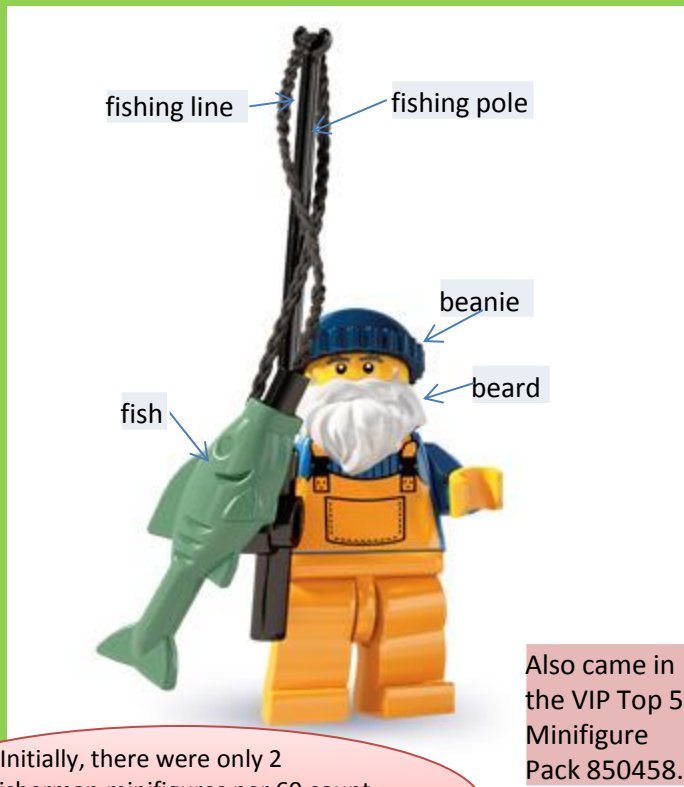

\*Initially, there were only 2 Fisherman minifigures per 60 count box (the rarest in Series 3), but this was later increased to 3 per box.

The Fisherman has sailed on every ocean, river, lake and stream in the world, and he has a story for each one. He can tell you all about the time he caught an entire school of flying fish with a butterfly net, was shipwrecked by a typhoon and escaped with the help of a friendly whale, or hooked a giant squid with nothing more than a fishing rod and an old rubber boot for bait.

Of course, no one believes these obvious tall tales, which makes the Fisherman a little cranky, because every single one of them is absolutely true. It's not his fault that he had to throw his catch back because it wasn't giant squid season yet, or that the batteries in his camera died that time he caught a sea serpent off the coast of Greenland. One day he'll bring back proof, and then everyone will finally believe his stories!

# Pilot

“This is just like when I outflew the Red Baron over the Sahara!”

BL Code	# in box	Value	# of parts	# of extras	Face sides	Gender	# of sales	Strength	Creativity	Speed
col03-2	4	\$2.88	7	0	1	M	431	3	2	4



In his day, the Pilot has flown just about everything with wings. Biplanes, triplanes, jetplanes, and seaplanes: he's piloted them all through every kind of wind and weather, and he's had all kinds of incredible experiences along the way. He's discovered long-lost mountaintop civilizations, battled sabotaging gremlins at 20,000 feet, and once he even flew a rocket to Mars to stop an invasion of water-stealing Moon Men.

Yes, the Pilot has led a colorful and exciting life indeed. He's long-since lost track of how many years he's been flying, although he definitely gave the Wright brothers some helpful advice at Kitty Hawk in Nineteen-Ought-Three. And if you even think of suggesting retirement, he'll just chuckle at you with a wink of his eye and a twirl of his elegant moustache, and start the propeller spinning for his next grand flight!

Inspired by the classic pilots and adventurers featured in British fiction.

Bio references the gremlin from *The Twilight Zone* "Nightmare at 20,000 Feet" episode.

# Tribal Chief

Rare

“On to the next adventure!”

BL Code	# in box	Value	# of parts	# of extras	Face sides	Gender	# of sales	Strength	Creativity	Speed
col03-3	3	\$4.58	6	0	1	M	248	3	2	3



The Tribal Chief lives for adventure. If there's a mountain, he'll climb it. If there's a river, he'll swim it. If there's a desert, he'll pack his bags and cross it, just because he can. All he needs is the great outdoors and an exciting challenge, and he'll be right there, daring it all and trying to get everyone he knows to join in on the fun.

As he sees it, his mission in life is to go everywhere and do everything the wide world has to offer...but the best part is that even when he's done everything he can think of doing, he knows that there will still be more adventures waiting just around the corner!

# Samurai Warrior

“A sword is only as strong as the heart that wields it.”

BL Code	# in box	Value	# of parts	# of extras	Face sides	Gender	# of sales	Strength	Creativity	Speed
col03-4	4	\$4.54	7	0	1	M	318	4	3	4



The Samurai Warrior is a legendary champion, famous for both his skill with the sword and his deep sense of honor. He will never break a promise or refuse to help a stranger in need, and the only reward he ever accepts for his noble deeds is a nice cup of hot tea afterwards.

The Samurai Warrior's only problem is that he's so extremely serious all the time. You can try telling him a joke, showing him a funny picture or even tickling him, but he'll never even crack a smile. It's rumored that he once laughed at one of the **Circus Clown's** gags, but if you ask him, he'll absolutely deny it!



# Snowboarder

Rare

“Cold enough for ya?”

BL Code	# in box	Value	# of parts	# of extras	Face sides	Gender	# of sales	Strength	Creativity	Speed
col03-5	3	\$3.52	7	0	1	F	241	2	3	5



When it's freezing cold outside and everyone else's teeth are chattering, the Snowboarder feels right at home. With nerves of steel, she'll brave the steepest slopes and the wildest jumps, confident that as long as there's snow on the ground, she can do anything. But as soon as the weather turns warmer and the snow starts to melt, she's out of there and heading wherever it's chillier!

The Snowboarder doesn't like to be anywhere that's even a little bit hot. She eats ice cream in the winter and volunteers at the aquarium's penguin pool in the summer. And what she likes to do most of all is head up a snow-covered mountain with her beloved board and have an icy good time in the cold!

Was originally planned to be a male minifigure.

# Space Villain

Rare

“There’s no villainy like space villainy!”

BL Code	# in box	Value	# of parts	# of extras	Face sides	Gender	# of sales	Strength	Creativity	Speed
col03-6	3	\$4.12	9	0	1	M	216	5	3	3



As a member of a shadowy criminal organization feared throughout the seven galaxies, the Space Villain really knows his outer space bad-guy stuff. He can hotwire a rocket neutron drive in zero-G, melt through solid plasmodic hypersteel with his nova-ray blaster, and sneak past a FuturonCorp security-bot in under 3.6 quarkoids, all while blindfolded.

Of course, full-time space villainy isn’t easy. Over the stellar cycles, the Space Villain has lost an eye in a warpship chase over Spyrius IV, misplaced a leg in the meteor mines of the Insectoid hivefleet, and he thinks his right arm might be somewhere at the other end of a black hole. Still, he wouldn’t give up his job for all the quasar rubies in the M-Tron Nebula...which just so happen to be the very next thing he’s planning to steal!

Bio references various space themes.

# Sumo Wrestler



“I am sorry, but I must defeat you now.”

BL Code	# in box	Value	# of parts	# of extras	Face sides	Gender	# of sales	Strength	Creativity	Speed
col03-7	5	\$2.54	6	0	1	M	605	3	2	3

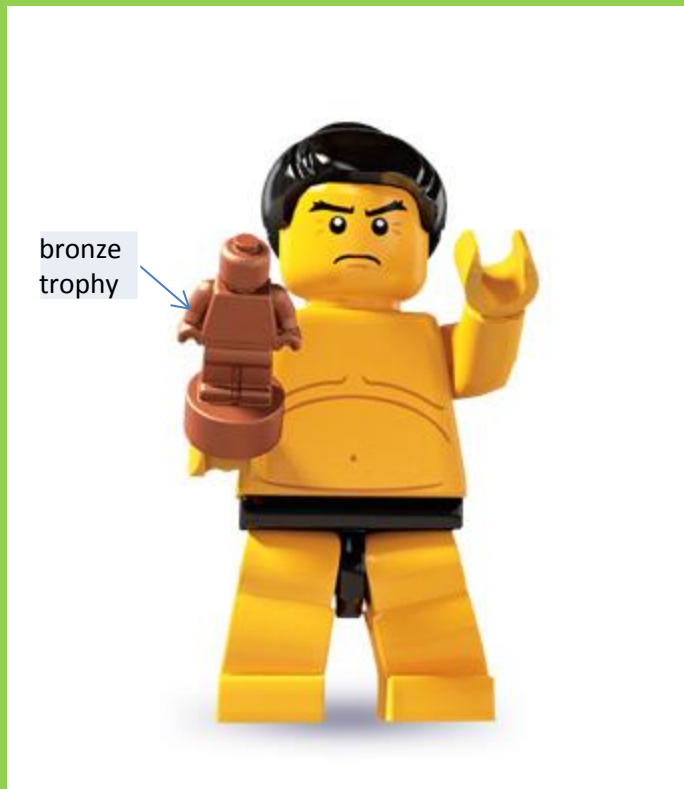

The Sumo Wrestler has dedicated his life to the ancient art of sumo. He has earned the nickname “The Immovable Object” for his ability to stand perfectly still while his opponent tries to push him over or out of the sumo ring. He’s recognized wherever he goes, and is always happy to stop and sign autographs for his many fans.

He may be big and strong (in fact, he’s VERY big and VERY strong), but the Sumo Wrestler is also extremely health-conscious. He watches his calories, makes sure to get plenty of fiber in his meals, and always finishes his vegetables. Like he says, you can’t get big and strong without taking good care of yourself!

# Mummy

“Zappo!”

BL Code	# in box	Value	# of parts	# of extras	Face sides	Gender	# of sales	Strength	Creativity	Speed
col03-8	5	\$3.07	5	0	1	M	265	5	1	1



Also came in the VIP Top 5 Minifigure Pack 850458.

The Mummy’s favorite thing to do is put ancient mummy curses on people. He just loves it when you wake up with slimy frogs in your bed, or suddenly find your shoelaces tied together, or have your toast always fall on the floor with the butter-side down.

But the Mummy doesn’t really mean any harm, and he’d be surprised if he ever found out that people thought he was being mean to them. As far as he knows, putting curses on people is just what mummies are supposed to do!

Fan  
Favorite

# Elf

MVP  
Price

Rare

“Trespass not in the secret glades of the Elves!”

BL Code	# in box	Value	# of parts	# of extras	Face sides	Gender	# of sales	Strength	Creativity	Speed
col03-9	3	\$8.23	8	0	1	M	350	5	3	5



Hailing from deep within the mystical forests of the Elflands, north of the great Western Kingdom, the Elf is a skilled master of the longbow and a wilderness scout without equal. He can walk over dried leaves and brittle twigs without ever making a sound, leap effortlessly through the tall treetops, and track a troll raiding party for days with no rest. You may have heard that the Elves are a mysterious and secretive people, but in fact they'll be happy to tell you all about their musical artistry with the harp and panpipes, their sworn friendship to the beasts of the woods, and their quest to rescue the enchanted Golden Goblet from the cavern of the Emerald Dragon. And then they'll break out the epic poetry!



# Tennis Player

“I win again!”

BL Code	# in box	Value	# of parts	# of extras	Face sides	Gender	# of sales	Strength	Creativity	Speed
col03-10	4	\$2.70	6	0	1	F	317	3	3	4



The Tennis Player trains hard to be the very best at the game, and she's got the athletic skills to show for it. Wherever the ball goes on the court, she's already there, ready to send it flying right back where it came from with a lightning-quick, precisely-aimed swing of her gleaming tennis racket.

And what a racket it is! Forged by a master racket-smith from the metal of a rare meteorite alloy, it's lightweight, perfectly balanced and almost indestructible. The Tennis Player never goes anywhere without it, and she's sure that with her lucky racket in her hand, she'll never lose a match!

# Race Car Driver

“Must...go...faster!”

BL Code	# in box	Value	# of parts	# of extras	Face sides	Gender	# of sales	Strength	Creativity	Speed
col03-11	5	\$2.42	7	0	1	M	114	3	2	5

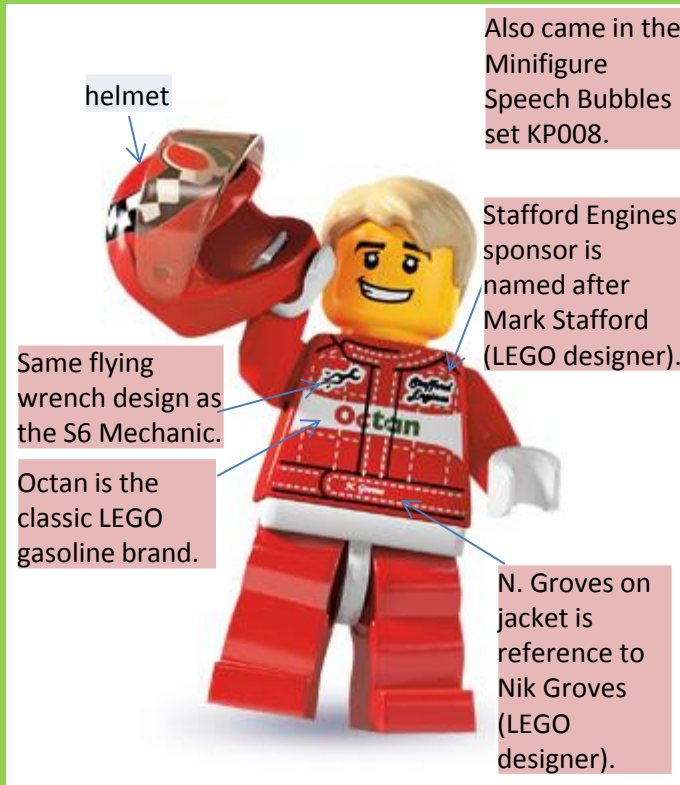

Years ago, the Race Car Driver met a mysterious man with a robot monkey who told him that he would be compelled to go faster and faster all his life. And it was true: from tricycle races to soapbox derbies, he has always been happiest when moving as fast as safety and the laws of physics will allow.

As soon as he was old enough to enter competitions, he was off and racing, constantly tweaking, modifying and tuning up his cars for more and more speed and power. Now that he's become a professional driver, he can finally do what he's always dreamed of doing: tour the world's racetracks in one of the fastest things on wheels!

# Gorilla Suit Guy

“Ook!”

BL Code	# in box	Value	# of parts	# of extras	Face sides	Gender	# of sales	Strength	Creativity	Speed
col03-12	4	\$4.23	6	0	1	M	601	3	1	2



The Gorilla Suit Guy is a mystery. Who is he? Why is he wearing that suit? Does he think he's an actual gorilla, or did he get lost on his way to a costume party? He certainly acts like the real thing, or at least like someone who's watched a lot of old movies and TV shows and thinks that's how a gorilla should act. And he sure is wild about bananas.

The Gorilla Suit Guy could turn up anywhere. In the park, at the beach, hanging out in a store window or jumping up and down on a trampoline, he tends to pop up in the most surprising and unlikely of places. And while he may not be a real gorilla, somehow no one ever wants to be the one to tell him that!

# Space Alien

“Take me to your traffic light, foolish Earth cupcakes!”

BL Code	# in box	Value	# of parts	# of extras	Face sides	Gender	# of sales	Strength	Creativity	Speed
col03-13	5	\$2.99	6	0	1	N	86	5	3	3



Nobody knows where the Space Alien came from or how it got here. It just showed up one day with a map of the planet and an Alien-to-Human dictionary, but neither one works very well. The map puts Washington D.C. in the middle of France, and the dictionary lists cows as a type of locomotive...which made things kind of complicated that time when the Space Alien tried to take a train to meet the President.

The Space Alien wants to conquer the planet, but it keeps getting sidetracked by interesting tourist attractions, so it hasn't really gotten around to the whole taking-over-the-world thing yet. It's also not sure what to do with the Earth once it's been conquered, but it's pretty sure that whatever it is, it'll be totally awesome!

# Hula Dancer

Rare

“Aloha, everybody!”

BL Code	# in box	Value	# of parts	# of extras	Face sides	Gender	# of sales	Strength	Creativity	Speed
col03-14	3	\$3.42	8	0	1	F	230	1	3	2



There's just something about being out in the sun that makes the Hula Dancer want to dance. She knows dozens of different hula dances in both traditional and modern styles, and she loves to perform them, no matter whether she's in front of an audience or all on her own.

There's only one thing that she likes better than dancing, and that's teaching other people to dance. If there's a big crowd around on a bright day, you can bet that the Hula Dancer is in the middle of it all, getting everybody to sing, play instruments and dance as long as the sun is in the sky!



# Rapper

Rare

“If you’ve got the time, I’ve got a rhyme!”

BL Code	# in box	Value	# of parts	# of extras	Face sides	Gender	# of sales	Strength	Creativity	Speed
col03-15	3	\$3.98	7	0	1	M	240	3	4	3

A similar but different version of this Minifigure came in the Rock Band Minifigure Accessory Set 850486.



The Rapper is a genius master of rhyming. He’s come up with rhymes for tricky words like “tugboat,” “larynx” and “zookeeper,” and he once even won a prize for finding a rhyme for “orange”.

He may not be a huge music celebrity yet, but the Rapper won’t give up until he’s made all of his dreams of success a reality. And as long as he never gets stumped on a rhyme, he’s sure to make it happen someday soon!

# Baseball Player

“Let’s get out there and give ‘em a great game!”

BL Code	# in box	Value	# of parts	# of extras	Face sides	Gender	# of sales	Strength	Creativity	Speed
col03-16	4	\$3.72	6	0	1	M	550	4	3	4

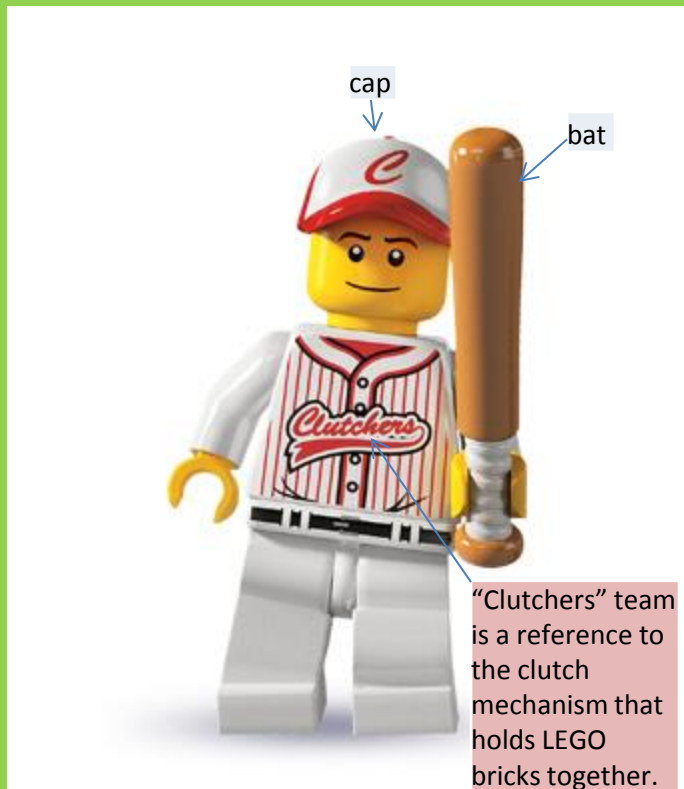

To the Baseball Player, nothing is as important as good teamwork. He memorizes all of his team’s game strategies, pays close attention to the coach’s signals, and does his best to help win no matter what position he’s playing. It’s not about personal fame or the number of home runs he hits – it’s about everybody having a good time on the field, and giving the crowd in the stands a terrific game to watch.

The Baseball Player isn’t just a professional athlete; he’s a big fan of the sport, too. He has an ever-growing collection of baseball memorabilia, from Bob Battingsley’s original rookie card to the signed bat of the world-famous “Brick” Ruth himself. But his top favorite is his mint-in-package collection of historic baseball stadium hot dogs. He’s almost got the complete set!

Bio alludes to Don Mattingly and Babe Ruth, famous Baseball players.

# Series 4 – April 2011

Avg price ea	Avg # of parts (not incl extras)	F count	M count	N count	# Sold last 6 mos	MVP Price Name	MVP Price
\$ 3.64	7.0625	3	13	0	6967	Hockey Player	\$5.74

LVP Price Name	LVP price	MVP Qty Name	MVP Qty	LVP Qty Name	LVP qty	Avg Set Price	Avg Case Price
Soccer Player	\$ 2.60	Hazmat Guy	712	Hockey Player	284	\$ 58.23	\$211.26



# Series 4 Stats

## Genders

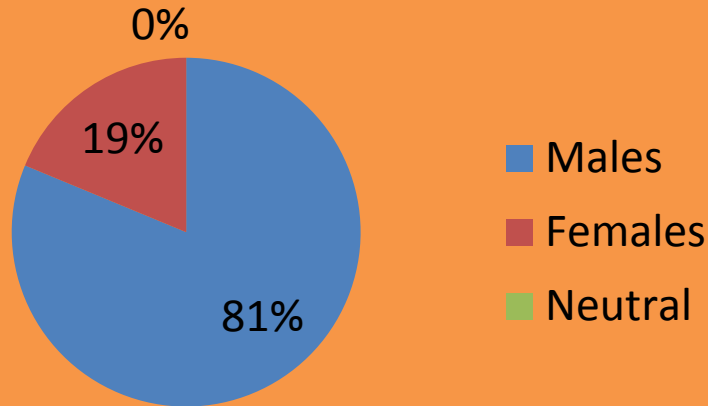

## Value

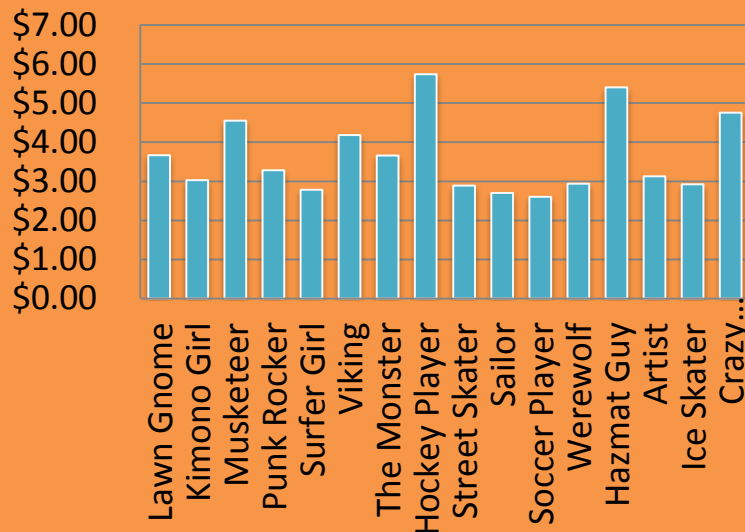

- Most Valuable = Hockey Player
- Most Popular = Hazmat Guy
- Least Valuable = Soccer Player
- Least Popular = Hockey Player
- Average Set Value = \$58.23
- Average Figure Value = \$3.85
- Average # of Pieces = 7.0625
- Rarest figures:
  - Lawn Gnome
  - Musketeer
  - Viking
  - Hockey Player
  - Ice Skater
  - Crazy Scientist

# Lawn Gnome

Rare

“I should really get a move on, but it’s just so nice here...”

BL Code	# in box	Value	# of parts	# of extras	Face sides	Gender	# of sales	Strength	Creativity	Speed
col04-1	3	\$3.67	8	0	1	M	419	3	2	3

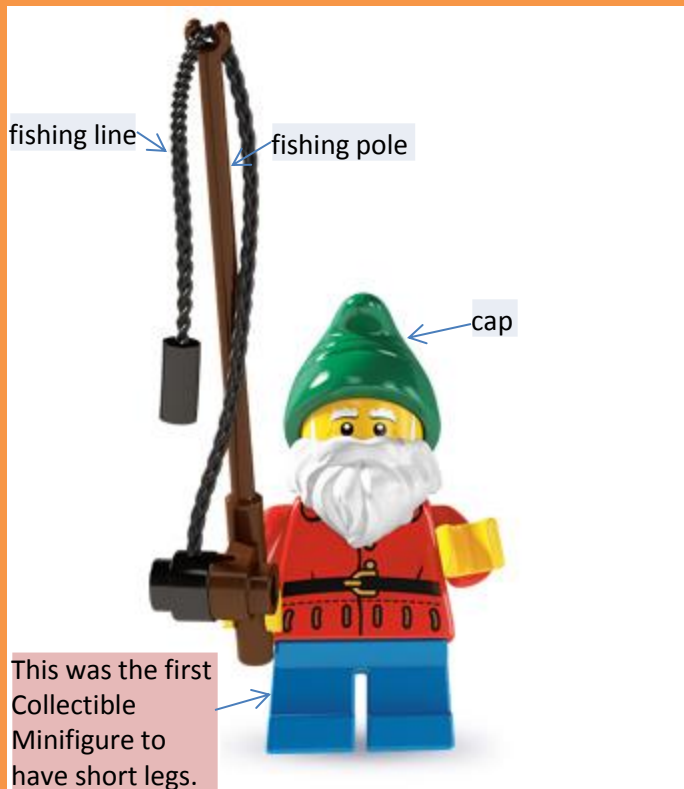

The Lawn Gnome is quite happy to stand perfectly still and watch the world go by. As long as the view stays interesting and the weather isn't too bad, he'll stay in one place for years on end, not budging even an inch no matter what may happen around him.

This may lead you to mistakenly believe that the Lawn Gnome is merely a statue. But the joke's on you if you pick him up and carry him home to your front yard, because if you don't give him something interesting to look at, he'll pack up his fishing pole and pointy green hat and be off on his way!



# Kimono Girl

“Hello, everyone / I am the Kimono Girl / This is my haiku.”

BL Code	# in box	Value	# of parts	# of extras	Face sides	Gender	# of sales	Strength	Creativity	Speed
col04-2	4	\$3.03	6	0	1	F	457	3	3	3



The Kimono Girl has the deepest respect for tradition. She has studied hard to learn exactly the way her traditional kimono robe should be worn, how her traditional makeup must be applied, and even just the right angle for holding her traditional folding fan.

The Kimono Girl's most favorite tradition of all is haiku poetry. She writes haiku verses about everything that she sees and does during the day. She's gotten so good at it that she can have entire conversations in lines of 5, 7 and 5 syllables!

Quote is a haiku (5 syllables 1<sup>st</sup> line, 7 syllables 2<sup>nd</sup> line, 5 syllables last line).

# Musketeer

Rare

“Do you dare to face my blade?”

BL Code	# in box	Value	# of parts	# of extras	Face sides	Gender	# of sales	Strength	Creativity	Speed
col04-3	3	\$4.55	7	0	1	M	457	3	2	3



To the dashing Musketeer, there's nothing in the world better than a clash of blades with a worthy opponent. Of course, when you're as good with a sword as he is, worthy opponents are pretty few and far between!

The Musketeer searches the world high and low for skilled adversaries. But alas, every duel ends in quick victory, and then there's nothing left to do but shake his defeated rival's hand with a thanks for trying. And then, with a smile, a wink and a bow, the Musketeer departs to seek his next opponent!

# Punk Rocker

“HEY! WHO’S READY TO ROCK?!”

BL Code	# in box	Value	# of parts	# of extras	Face sides	Gender	# of sales	Strength	Creativity	Speed
col04-4	5	\$3.28	6	0	1	M	389	4	4	3

A similar but different version of this Minifigure came in the Rock Band Minifigure Accessory Set 850486.

electric guitar

T-shirt design based on a tattoo that Michael Patton (LEGO designer) has.



The Punk Rocker never goes anywhere without his favorite electric guitar, and as long as that guitar is in his hands, you can be sure that he'll be rocking up a storm...and waking up everybody in the neighborhood while he's at it.

There are all kinds of legends about the noisy Punk Rocker. Some say that he used to be shy and quiet until he got hit by a bolt of lightning one day. Some say that he's sworn never to stop rocking until his music has created world peace. But whatever you may believe, one thing that everybody has to agree on is that the Punk Rocker is very, very, very LOUD!

# Surfer Girl

“The best wave is always the next wave!”

BL Code	# in box	Value	# of parts	# of extras	Face sides	Gender	# of sales	Strength	Creativity	Speed
col04-5	4	\$2.78	6	0	1	F	296	3	3	4



The Surfer Girl loves everything about the ocean, from the biggest sandy beach to the tiniest tropical fish. She's happy just to be in the water, and she's even happier still when she finds a new surfing challenge to test her skill.

As long as the sky is clear and the surf is wild, the Surfer Girl can be found right in the middle of her element, riding the tallest wave she can find and whooping at the top of her lungs the whole way back to the beach. And as soon as she reaches the shore, she runs right back into the water to chase the next big splash!

# Viking

Rare

“There are monsters everywhere, and I’m just the Viking to fight them!”

BL Code	# in box	Value	# of parts	# of extras	Face sides	Gender	# of sales	Strength	Creativity	Speed
col04-6	3	\$4.18	10	0	1	M	398	5	3	3

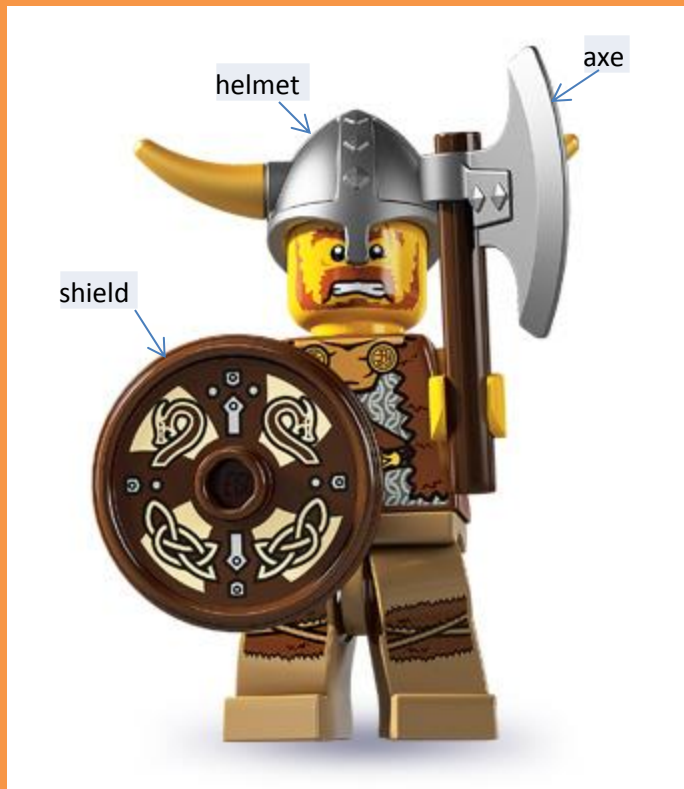

Raised on heroic ballads of sea serpents, forest trolls and fire-breathing dragons, the fearless Viking sees monsters everywhere – and the most important thing he knows about monsters is that when a Viking sees one, he’s got to fight it!

With axe and shield in hand, the Viking happily plunges into battle like a shouting whirlwind of clattering, clashing leather and iron. He’s ready to take on any monster he spots, and it can take some explaining to get him to understand that plenty of monsters aren’t really all that bad!



# The Monster

“Monster here to help!”

BL Code	# in box	Value	# of parts	# of extras	Face sides	Gender	# of sales	Strength	Creativity	Speed
col04-7	4	\$3.66	5	0	1	M	434	5	2	4



He may look a little alarming, but The Monster just wants to help everybody out. It's really not his fault that he was constructed with tremendous strength and always ends up accidentally smashing everything around him into lots and lots of little bricks.

Whenever The Monster sees somebody struggling with a heavy load or trying to stack the last piece up on top of a wall, of course he runs right over to lend an enthusiastic helping hand. And no matter how many people may scream and run away, or how many building projects he may accidentally destroy, he always stays just as cheerful and friendly as the day he was first put together!

# Hockey Player

“Grrrr!”



BL Code	# in box	Value	# of parts	# of extras	Face sides	Gender	# of sales	Strength	Creativity	Speed
col04-8	3	\$5.74	11	0	1	M	284	5	4	5



Raised by wild wolves out on the frozen tundra until he was discovered by a traveling sports agent, the Hockey Player quickly proved to have a natural talent at the fierce and fast-paced sport of ice hockey. Whether he's chasing the puck across the rink or guarding his team's home goal, he's dedicated to one thing and one thing alone: winning the game! No one's faster or tougher on the ice than this ferocious fellow, and no one's more loyal to his team, either. Rival players have learned not to get too close to the Hockey Player when he's 'in the zone.' Why's that? Let's just say that the cage on his helmet isn't only for his own protection!

# Street Skater

“This is the perfect spot for an awesome new stunt!”

BL Code	# in box	Value	# of parts	# of extras	Face sides	Gender	# of sales	Strength	Creativity	Speed
col04-9	4	\$2.89	8	0	1	M	344	3	4	4

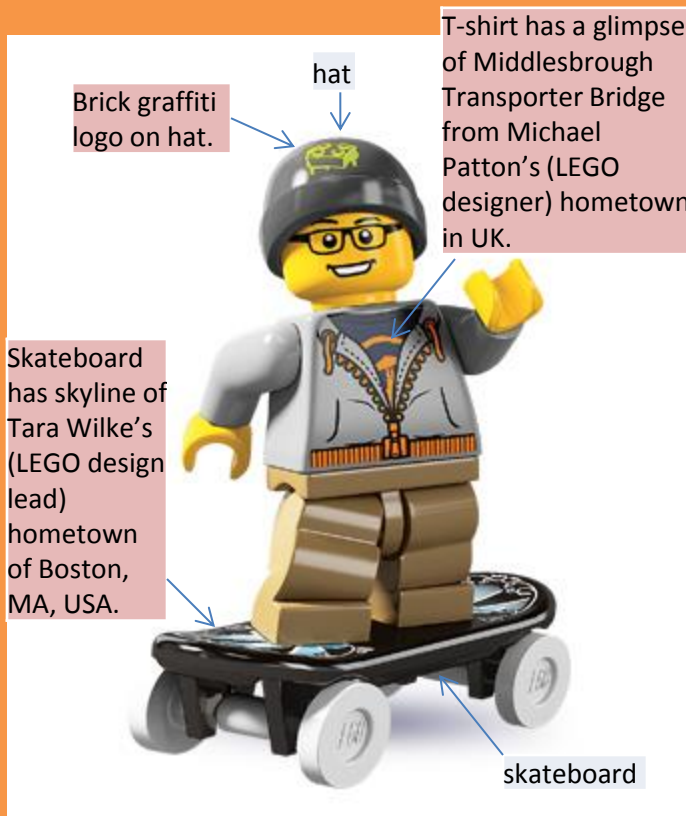

To the Street Skater, the whole city is one big skate park. No matter where in town he may be, everything around him looks like just the right location for his next mind-blowing skateboarding stunt.

People all over the city are used to seeing the Street Skater rolling up and down stairs, along railings, through fountains and even across the branches of the city park's trees. He's such a familiar sight that the streets just wouldn't be the same without him and his famous skateboard!

# Sailor

“Aye aye, Cap’n!”

BL Code	# in box	Value	# of parts	# of extras	Face sides	Gender	# of sales	Strength	Creativity	Speed
col04-10	5	\$2.70	6	0	1	M	536	3	3	3



The brave and trusty Sailor can always be counted on in a nautical emergency. He can tie knots like nobody's business, spot a lighthouse through his spyglass from a hundred leagues' distance in the middle of a storm, and hoist a mainsail or batten down the hatches in no time flat.

The Sailor has spent his whole life at sea, and he knows every tide and fathom like the back of his hand. He just doesn't feel like himself if he's not out on a sailing ship, feeling the deck roll beneath his feet and hearing the gulls squawking overhead. Freedom, adventure and the great wide sea: that's the life for him!

# Soccer Player

“Follow my lead!”

BL Code	# in box	Value	# of parts	# of extras	Face sides	Gender	# of sales	Strength	Creativity	Speed
col04-11	4	\$2.60	7	0	1	M	339	3	3	5



The Soccer Player has led the Brick Kickers team to many victories, and the other players all respect his strategy and skill on the field. He's a fast runner, an accurate kicker, and he's knocked so many soccer balls into the goal with his head that the fans joke that it's made of steel.

He may not win every game, but the Soccer Player always does his best and plays with a smile. It's earned him a reputation as both a good sportsman and a good sport who's almost as happy with a hard-earned second place as he is with a first-place trophy!



# Werewolf

“Aroooo!”

BL Code	# in box	Value	# of parts	# of extras	Face sides	Gender	# of sales	Strength	Creativity	Speed
col04-12	5	\$2.94	6	0	1	M	605	5	2	5

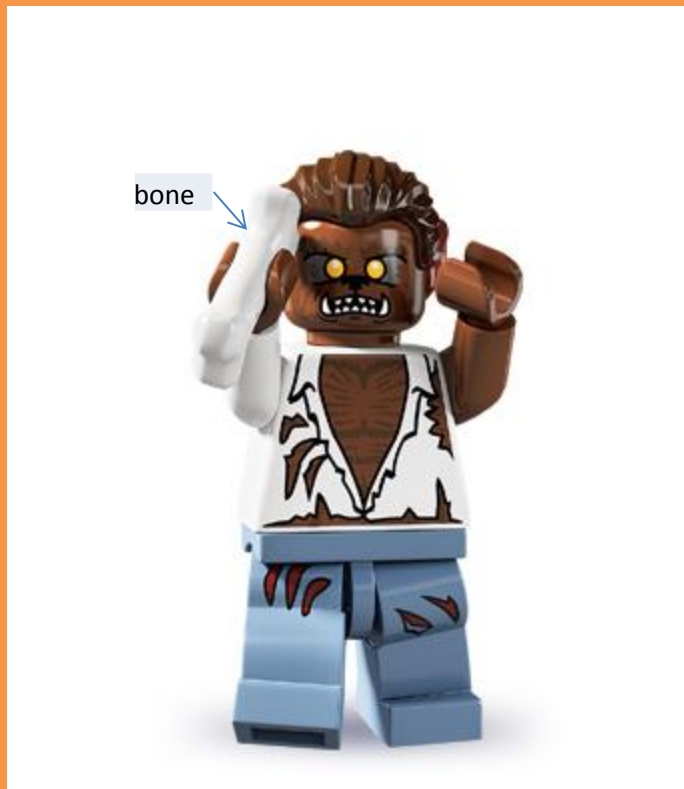

Whenever the full moon rises high in the night sky, the Werewolf undergoes a startling transformation into a half-man, half-beast creature. Unable to control his primal instincts, he rampages across the countryside, terrifying all who encounter him!

...Okay, he actually just digs holes, buries chew toys in the yard, and romps around the park fetching sticks. It's all a little embarrassing for the Werewolf, so if you happen to see him running around in circles trying to catch his own tail, please try to act scared. It'll mean a lot to him.

# Hazmat Guy

“This is a job for the Hazmat Guy! Er, do you smell something funny?”

BL Code	# in box	Value	# of parts	# of extras	Face sides	Gender	# of sales	Strength	Creativity	Speed
col04-13	4	\$5.40	6	0	1	M	712	3	2	3

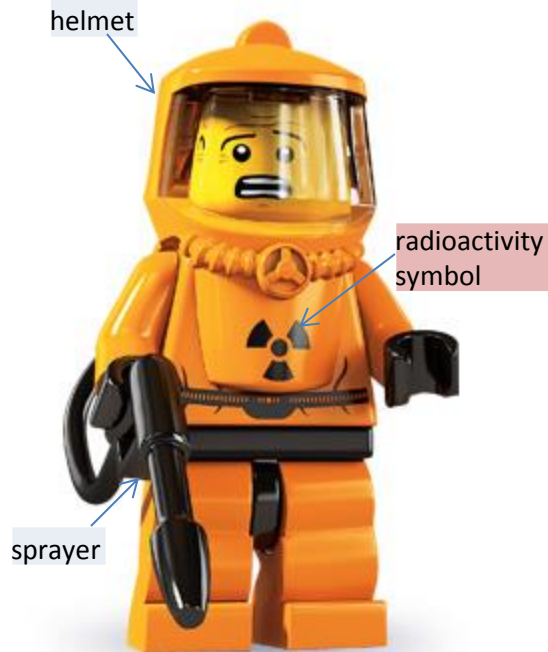

When you’ve got a bad case of mysterious glowing goo in your city, the hard-working Hazmat Guy is just the fellow to call. Whether the job involves searching the sewers for dirty sludge or cleaning up old apartments, he’s always ready to put on his airtight protective suit, grab his hi-tech equipment, and make the streets safe and tidy once more.

Of course, when you get sent into dangerous situations to handle hazardous materials every day, you’re bound to get a little jittery. Although he never backs away from an emergency, the Hazmat Guy is always nervous that this is the one time his gear won’t work. After all, with all of the crazy substances he’s been exposed to, it’s a wonder he hasn’t grown an extra face on the other side of his head!

# Artist

“All the world is my canvas, and I must paint it!”

BL Code	# in box	Value	# of parts	# of extras	Face sides	Gender	# of sales	Strength	Creativity	Speed
col04-14	4	\$3.13	7	0	1	M	495	2	5	2



Expression was inspired by Jason Ralls, Tara Wilke's (LEGO designer) husband.

Everything the Artist sees inspires him to paint. The sunset, the sky, the bugs, passing airplanes...each one gives him the idea for a truly magnificent work of art, and he is consumed with painting them until he is done.

Since he doesn't carry a canvas with him everywhere he goes, though, this leads to him painting on whatever surface happens to be handy. He paints on walls, rocks, trees and anything else he can find. You'd think it might get him in trouble, but his artistic creations are so spectacular that no one ever seems to mind!

# Ice Skater

Rare

“Just give me music and I’ll skate to it!”

BL Code	# in box	Value	# of parts	# of extras	Face sides	Gender	# of sales	Strength	Creativity	Speed
col04-15	3	\$2.92	8	0	1	F	367	3	4	4



Elegant, graceful and light on her feet, the Ice Skater can create an elaborate figure skating routine for any music...any music at all! Just play something, no matter how fast or slow, loud or soft, and she’ll show you a dazzling display of ice skating skill that will leave you applauding and shouting for more.

But that’s not all! For her most stunning feat, the Ice Skater will start out up at the top of a huge block of ice and begin to skate. By the time she’s done with all of her spinning jumps and pirouettes, she’s used her shining skates to carve out a beautiful ice sculpture based on any subject you choose!

# Crazy Scientist

Very  
Rare

“Ah hah hah hah! They called me mad at the university...and they were right!”

BL Code	# in box	Value	# of parts	# of extras	Face sides	Gender	# of sales	Strength	Creativity	Speed
col04-16	2	\$4.76	6	0	1	M	444	3	5	3



The Crazy Scientist really loves mad science. He's got all the right equipment: a spooky old laboratory, shelves of beakers and tubes full of bubbling liquids, and even one of those antenna things with the little bolts of lightning that go up and down. He's still looking for just the right creepy assistant, but he's sure that one will answer his ad soon.

On the other hand, there are the experiments. **The Monster** was one, but just like the rest, it didn't turn out quite as planned. It was supposed to be all evil and scary, but instead it turned out friendly and nice. No matter how hard he may try, the Crazy Scientist can't seem to create anything really bad. He just doesn't know where he's going wrong, and it's driving him crazy!





# Series 5 Stats

## Genders

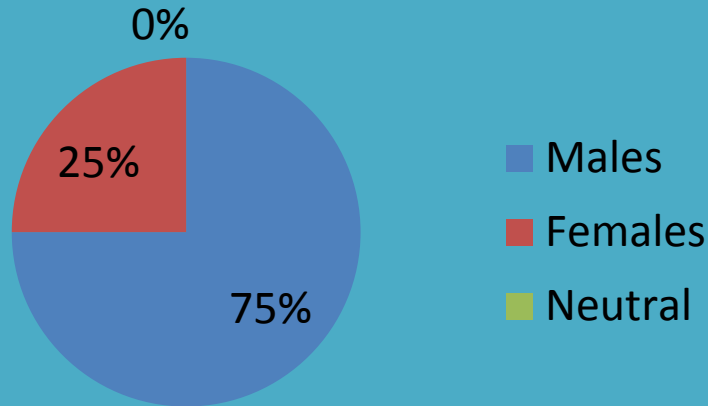

## Value

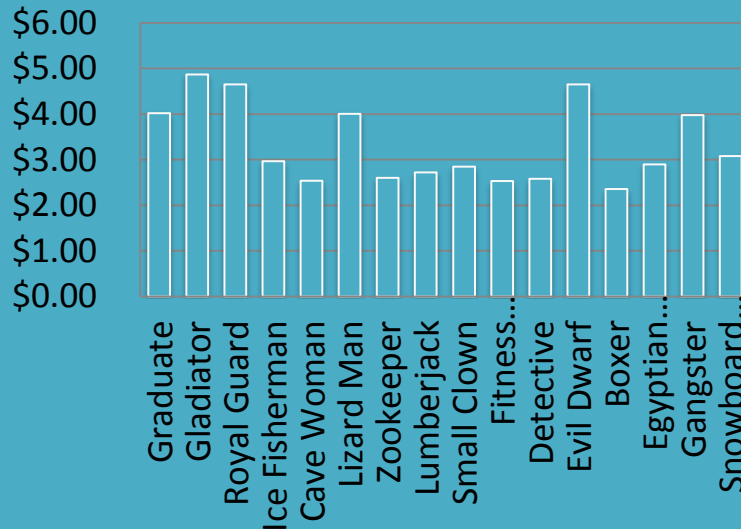

- Most Valuable = Gladiator
- Most Popular = Boxer
- Least Valuable = Boxer
- Least Popular = Cave Woman
- Average Set Value = \$53.31
- Average Figure Value = \$3.33
- Average # of Pieces = 6.625
- Rarest figures:
  - Graduate
  - Gladiator
  - Ice Fisherman
  - Evil Dwarf
  - Egyptian Queen
  - Gangster
  - Snowboarder Guy

# Graduate

Rare

“I did it! I finally did it!”

BL Code	# in box	Value	# of parts	# of extras	Face sides	Gender	# of sales	Strength	Creativity	Speed
col05-1	3	\$4.02	7	0	1	M	480	2	5	2

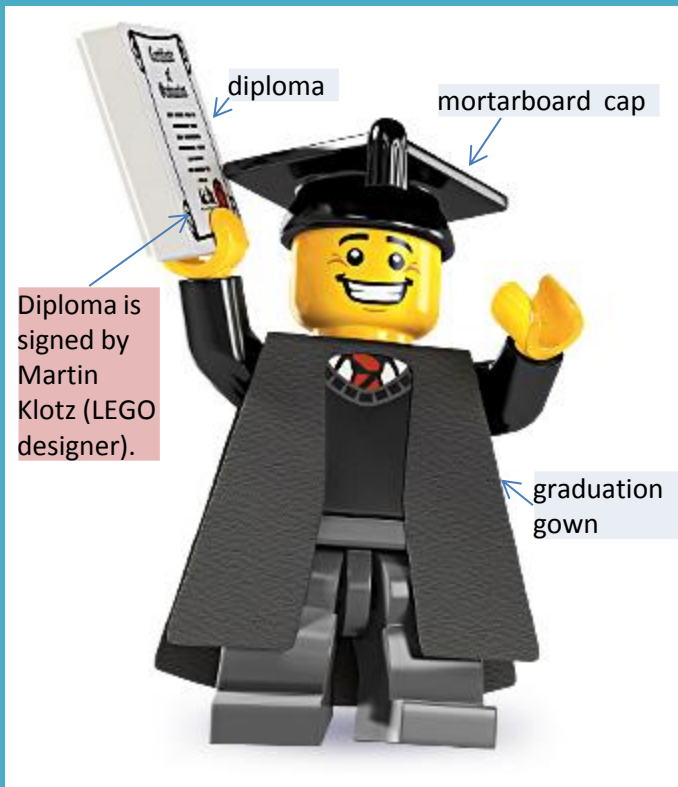

The Graduate loved everything about college. The classes, the teachers, and even the homework and the late nights of studying...it's been an amazing journey, and it's all led to this single long-awaited, triumphant moment of his name being called on Graduation Day.

The Graduate would like to thank his family, his professors and his friends. He couldn't have done it without them! And now that he stands here in his robe and graduation cap, clutching his precious, hard-earned diploma in his hand, he looks out at all the people watching him and one single thought fills his mind: oh man, now he's got to go find a job!

Fan  
Favorite

# Gladiator

“Can’t we all just get along?”

MVP  
Price

Rare

BL Code	# in box	Value	# of parts	# of extras	Face sides	Gender	# of sales	Strength	Creativity	Speed
col05-2	3	\$4.87	7	0	1	M	518	4	2	4

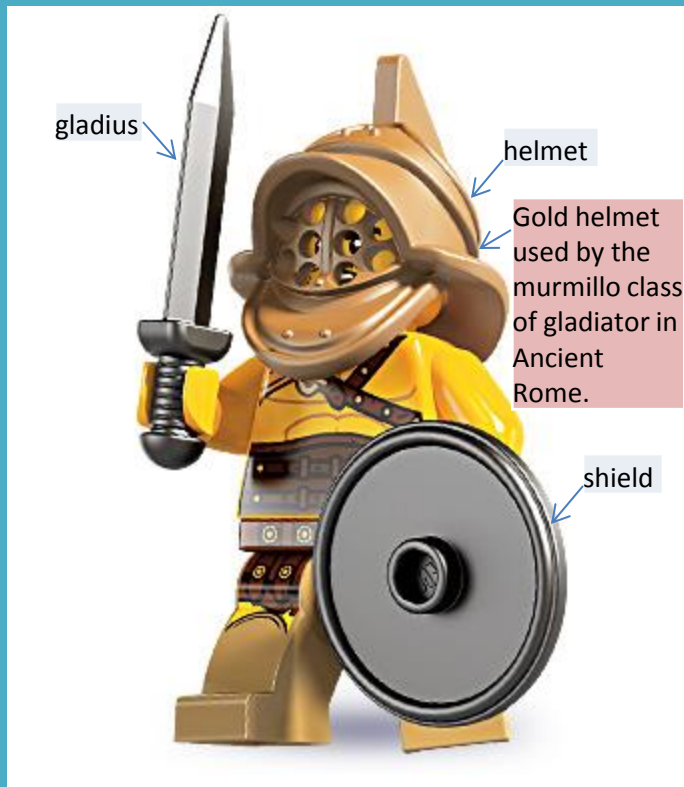

The Gladiator has trained all his life with his sword and shield, and there are few more skilled at battling warriors and wild beasts in the arena. He knows it is his duty to thrill the audience with an action-packed display of fighting prowess, and he has proven himself a champion over and over again.

But sometimes, deep down inside, the Gladiator wonders if there might be other kinds of entertainment out there. Something that isn't quite so hot and tiring. Something where you never get poked with the pointy end of a trident. If only something like that existed, maybe – just maybe – he might find himself an easier line of work!

# Royal Guard

“Sorry, sir! I’m not allowed to speak!”

BL Code	# in box	Value	# of parts	# of extras	Face sides	Gender	# of sales	Strength	Creativity	Speed
col05-3	5	\$4.65	6	0	1	M	928	3	2	2



The steadfast Royal Guard is utterly devoted to his job as a protector of the palace and the royal family. In rain or shine, in hot summer sun or freezing winter night, he can always be found standing at his post at perfect attention, staring straight ahead with his tall, furry hat on his head and his ceremonial rifle in place at his shoulder.

No matter how much you try to distract the Royal Guard, he’ll never even blink an eye. You can tell him jokes, dress up in silly costumes and even try to tickle him, but he won’t move at all. He and his fellow guards are silent, stalwart sentinels, never uttering a word aloud – and that’s exactly what he’ll tell you if you ask him!

Homage to the guards who stand outside Buckingham Palace in London, England.



# Ice Fisherman

Rare

“Wait, and all good things will come to you.”

BL Code	# in box	Value	# of parts	# of extras	Face sides	Gender	# of sales	Strength	Creativity	Speed
col05-4	3	\$2.97	8	0	1	M	366	3	2	4

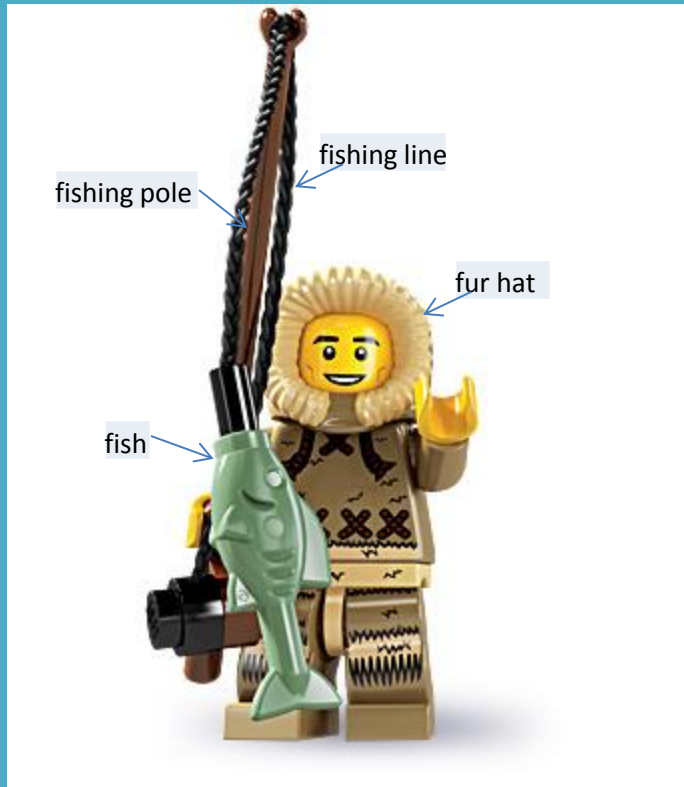

The Ice Fisherman might be the most patient person in the world. He'll carefully choose just the right spot on the ice to drill a hole, then he'll lower his fishing line and wait...and wait...and wait. He might wait for hours. He might wait for days. Sometimes he even waits for weeks! But eventually, there's always a tug on the line and up pops his catch.

It's not just fish, though. It seems like the longer the Ice Fisherman waits there at his little hole in the ice, the better the thing he catches will be. He once caught a ship in a bottle. Another time, it was a treasure chest full of gold and jewels. And once, after three long months of sitting and waiting through the cold Arctic winter, he even fished up a magic lamp with a wish-granting genie. (The first thing he wished for? A warmer coat!)

# Cave Woman

“You keep on painting, dear. I’ll take care of that pesky saber-tooth.”

BL Code	# in box	Value	# of parts	# of extras	Face sides	Gender	# of sales	Strength	Creativity	Speed
col05-5	4	\$2.54	7	0	1	F	253	3	3	5



While the **Caveman** is trying to build new inventions, the Cave Woman is the one who actually gets all the practical things done. She smashes rocks to make tools, creates clothing out of hides and skins, chases off big meat-eaters and assembles clever traps for catching supper using sticks, stones and bits of shells.

Despite having a bigger brain, the Cave Woman is very fond of her dim-witted mate. Recently, she’s been thinking about doing some inventing herself, perhaps starting with a written language and a stone-based calendar system. Maybe then she’ll finally be able to get the **Caveman** to remember his own name...not to mention her birthday!

# Lizard Man

“Stomp stomp stomp! Flee, tiny citizens! Flee!”

BL Code	# in box	Value	# of parts	# of extras	Face sides	Gender	# of sales	Strength	Creativity	Speed
col05-6	4	\$4.01	6	0	1	M	844	5	3	2



First minifigure to have a molded tail.

The Lizard Man lives to trample cities beneath his big green feet. Of course, since he’s really just a minifigure of normal size wearing a lizard suit, that’s not as easy as it sounds...so instead, he spends hours building his own meticulously detailed miniature buildings and then stomping all over them while making roaring noises. When your greatest dream is to be a giant monster, it’s tough to find new hobbies. The Lizard Man sometimes thinks about becoming a professional wrestler, but the **Gorilla Suit Guy** never writes back to any of his challenges. On the other hand, rumor has it that the **Super Wrestler** would be happy to take him up on the offer anytime!

# Zookeeper

“Now, who was it that gets the banana, and who gets the bucket of fish?”

BL Code	# in box	Value	# of parts	# of extras	Face sides	Gender	# of sales	Strength	Creativity	Speed
col05-7	5	\$2.60	7	0	1	F	415	3	2	3



The Zookeeper has loved animals ever since she first visited the monkey house at the zoo as a small child. From cats and dogs to elephants and ostriches, she's studied every species and knows all the healthiest foods to feed them and the best habitats and activities to keep them happy. Living and working in LEGO CITY, the Zookeeper has had to look after some pretty strange creatures in her career. Of course, there are the usual camels and bats and colorful jungle frogs, but nobody ever warned her about dragons and rock monsters, not to mention what that one team of adventurers brought back from their expedition to Dino Island!

Bio mentions Dragons from Castle and Ninjago themes, Rock Monsters from Rock Raiders and Power Miners, and Dinosaurs from the Adventurers' expedition to Dino Island.

# Lumberjack

“I’m okay!”

BL Code	# in box	Value	# of parts	# of extras	Face sides	Gender	# of sales	Strength	Creativity	Speed
col05-8	4	\$2.72	6	0	1	M	416	5	2	3

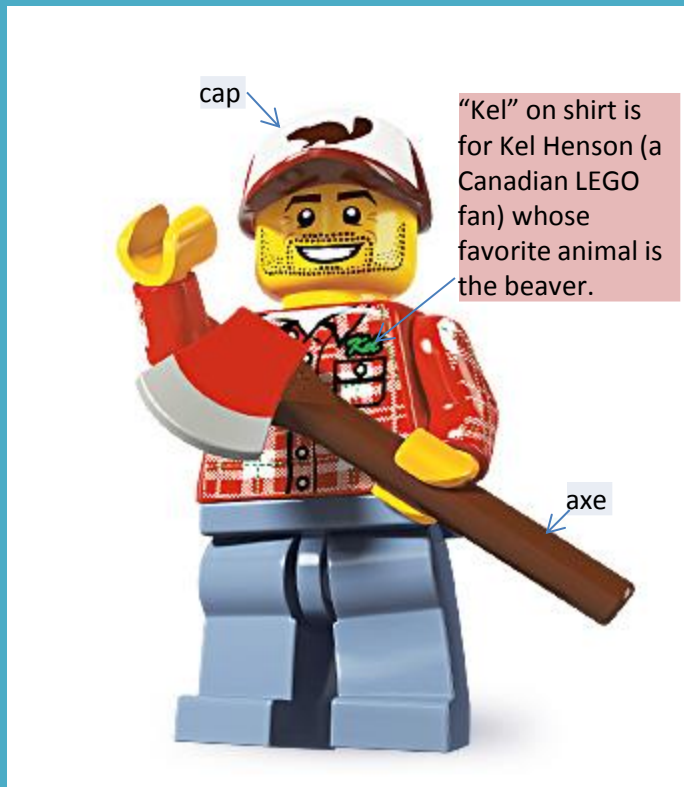

The rugged Lumberjack is a true man of the outdoors. He builds his own log cabins, tends his own campfires, cooks his own stews and brews his own maple syrup. The only times he ever goes back to the big city are when he needs to drop off a load of freshly-cut lumber or buy a new cap because his last one got eaten by a bear. Although the Lumberjack is strong of arm and staunch of heart, he isn’t always the best at aiming trees the right way when he chops them down with his shiny axe. Half the time, they end up crashing right down on top of him – so it’s probably a good thing he’s also pretty hard of head!

Quote is based on a song by the Monty Python comedy troupe.

# Small Clown

“Hey! Did somebody here order a PIE?”

BL Code	# in box	Value	# of parts	# of extras	Face sides	Gender	# of sales	Strength	Creativity	Speed
col05-9	4	\$2.85	6	0	1	M	491	2	5	3



The Small Clown is totally serious about making people laugh. He’s memorized every joke book in the library, subscribes to several clowning magazines, and has a graduate degree in Advanced Mirth from Clown University. His philosophy is that if you’re not laughing, he’s not doing his job right.

The way he sees it, he may be just a small clown, but he’s got really big shoes to fill. All of the famous and beloved clowns of yesteryear are counting on him to uphold their classic traditions of hilarity, and he doesn’t want to let them down. That’s why he rehearses hard to have the very best and funniest clown routines around. Plus, it lets him hit people with pies!



# Fitness Instructor

“Don’t fall down now! We’re just getting warmed up!”

BL Code	# in box	Value	# of parts	# of extras	Face sides	Gender	# of sales	Strength	Creativity	Speed
col05-10	4	\$2.53	6	0	1	F	266	3	4	4

Boombox based on radio owned by Tara Wilke’s (LEGO designer) best childhood friend.



boombox

The Fitness Instructor has devoted herself to one thing and one thing only: getting people in great shape! With the help of a boom-box full of energetic workout tunes and a wall full of degrees in aerobics, yoga and more, she leads fitness sessions and promotes good health wherever she goes. With her endless energy and enthusiasm, the Fitness Instructor makes exercise look like so much fun that you just can’t resist joining in. But if you do, be prepared for the workout of a lifetime, because she’ll keep going and going long after everybody else is ready to drop from exhaustion!

# Detective

“Why, the solution is as simple as clicking two bricks together!”

BL Code	# in box	Value	# of parts	# of extras	Face sides	Gender	# of sales	Strength	Creativity	Speed
col05-11	4	\$2.58	6	0	1	M	338	3	5	3



Inspired by  
Sherlock Holmes.

If you've got a major mystery to solve, the Detective is your minifigure. He's famed across the land for his amazing deductive skills, and he never gives up on a case, no matter how impossible it may at first appear. He just whips out his magnifying glass, follows the clues, and always arrives at the right solution in the end.

You may have heard of some of the Detective's most famous cases. He's the one who single-handedly solved the Brickster's Baffling Brick-Napping, the Sam Sinister Switcheroo, and the Mystery of Timmy's Nose. Why, he even tracked down a missing pet from the Racing Drome...and robot monkeys don't leave footprints!

Bio references The Brickster from LEGO Island, Sam Sinister from Adventurers, Timmy from Time Cruisers, and the Racing Drome and robotic monkey from the Drome Racers.

# Evil Dwarf

Rare

“Nobody mocks my beard!”

BL Code	# in box	Value	# of parts	# of extras	Face sides	Gender	# of sales	Strength	Creativity	Speed
col05-12	3	\$4.65	10	0	1	M	375	4	2	5



Whatever you do, don't make fun of the Evil Dwarf's beard! You can tell him his armor is squeaky, his axe is rusty or his iron helmet is totally unfashionable for modern dwarf society, and he'll just grin and laugh. But say one word about his prized whiskers and you'd better hope you can run away fast!

Ever since he was a lad in the deep-down Dwarven Kingdom, the Evil Dwarf has been proud of his bristling black beard. It turned him into quite the bully! Imagine his surprise when he discovered that not everybody on the surface respected fine follicle growth. Now the Evil Dwarf sells his formidable battle skills to whoever offers him the most gold – as long as they never, ever belittle the beard!

# Boxer

MVP  
Qty

“I’m gonna be the greatest!”

BL Code	# in box	Value	# of parts	# of extras	Face sides	Gender	# of sales	Strength	Creativity	Speed
col05-13	5	\$2.36	5	0	2	M	1020	5	2	4

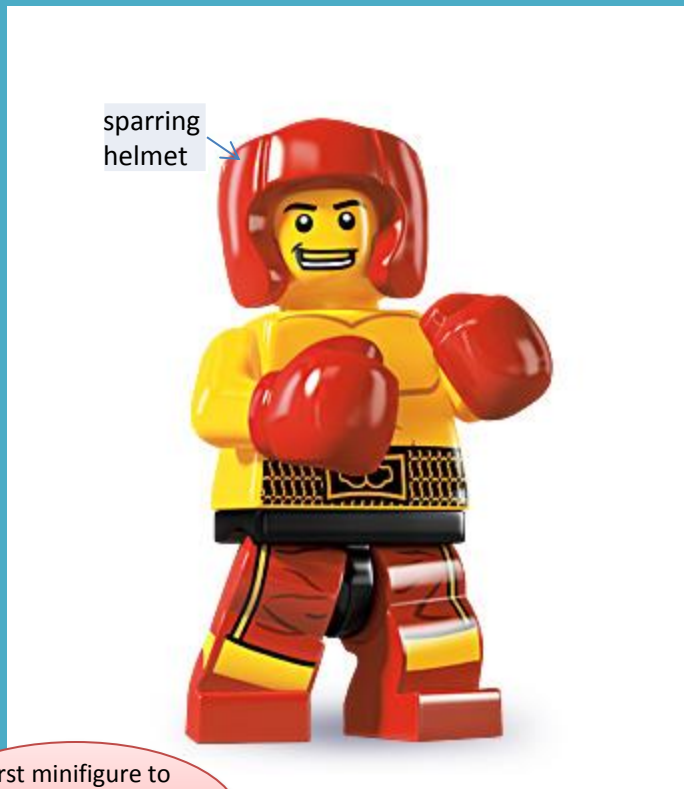

First minifigure to have both hands replaced with accessories.

The Boxer’s fancy footwork and lightning-fast fists have earned him fans all over the world – but his biggest fan of all is the Boxer! He’s convinced that he’ll be the best professional prize fighter in the world one day, and his current winning streak suggests that he just might be right.

The Boxer has defeated every opponent he’s faced in the ring so far, and he’s always looking for the next big challenge. He was even hoping to box a kangaroo until he was told that was only something that happened in cartoons. He’s convinced that if science would just invent the perfect cloning machine, he could finally box against the one person who could give him a tough match: himself!

# Egyptian Queen



“Asp me no questions, and I shall tell you no lies.”

BL Code	# in box	Value	# of parts	# of extras	Face sides	Gender	# of sales	Strength	Creativity	Speed
col05-14	3	\$2.90	6	0	1	F	343	2	3	2



The Egyptian Queen is used to the finer things in life, but don't think for a moment that it's made her soft! She may have a golden throne, banquets five times a day and legions of loyal servants to obey her every command, but she also knows all about tax codes, crop rotation and pyramid construction regulations, not to mention the ancient game of politics.

The Egyptian Queen loves to disguise herself as a commoner and listen to what her subjects are saying about her. Of course, since everybody knows what she looks like (she's on all the coins and statues, after all), they're always careful to say only nice things. It isn't too hard, since for an all-powerful sovereign, she's really not too bad!

# Gangster

Rare

“Stick ‘em up and hand over all your – aw no, it’s the cops again!”

BL Code	# in box	Value	# of parts	# of extras	Face sides	Gender	# of sales	Strength	Creativity	Speed
col05-15	3	\$3.98	7	0	1	M	371	4	3	4

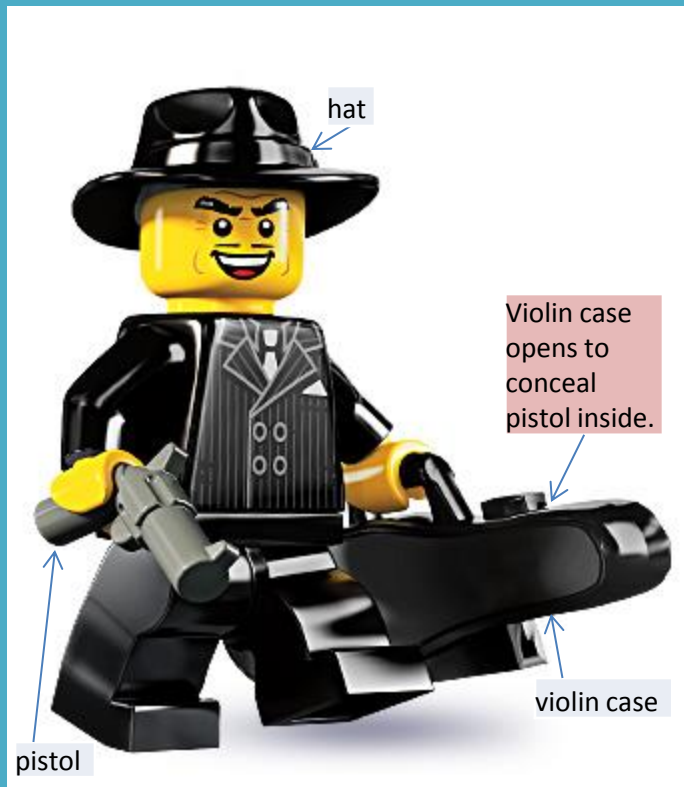

The Gangster is a low-down, sneaky, rotten crook. Impeccably dressed in his pinstripe suit and hat, his trick violin case always at his side, he sneaks around the city setting up scams, bank robberies and protection rackets wherever he can...or at least, that's the plan.

The problem with being a no-good criminal in LEGO CITY is that the place is just chock full of police stations. You can hardly turn a corner without running into a friendly officer or three out on patrol. So as much as the Gangster may try to make his fortune through unlawful acts, he usually finds himself spending a lot more time fleeing than committing felonies!



# Snowboarder Guy

Rare

“Is that the new 80-3RX? I’ve been waiting to try this baby out!”

BL Code	# in box	Value	# of parts	# of extras	Face sides	Gender	# of sales	Strength	Creativity	Speed
col05-16	3	\$3.08	6	0	1	M	346	3	4	5



“48 mm” is the exact length of the LEGO snowboard piece.

The Snowboarder Guy knows everything there is to know about wind speed, slope angle and exactly how much wax to put on your board for the smoothest ride, and he puts his knowledge to good use by being the very best snowboard tester in the world.

If you’ve come up with a brand-new board design, the Snowboarder Guy is just the guy to check it out. He’ll put it through its paces with an amazing series of snowboarding moves, and finish up by telling you just how it compares to all the other models out there. Better hope you’ve made a good one, though, because he never holds back with his opinion!



# Series 6 Stats

## Genders

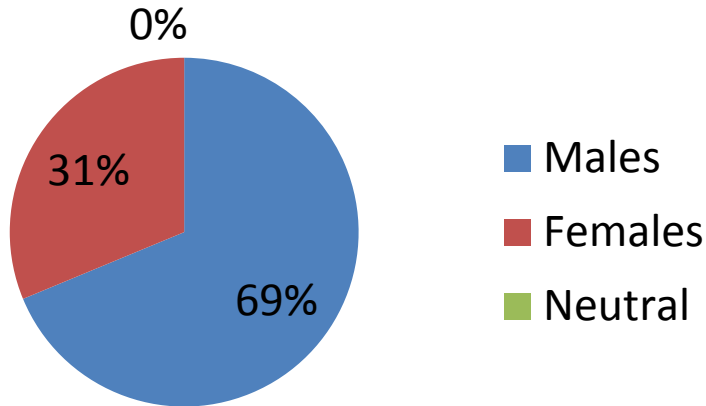

## Value

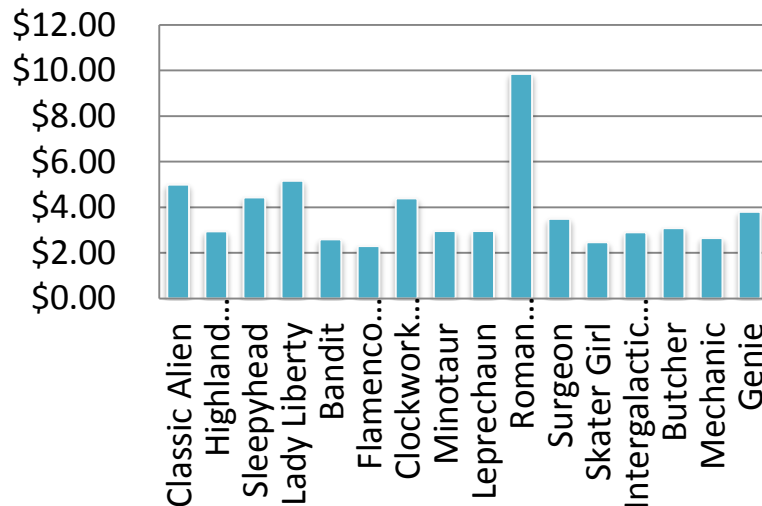

- Most Valuable = Roman Soldier
- Most Popular = Minotaur
- Least Valuable = Flamenco Dancer
- Least Popular = Mechanic
- Average Set Value = \$61.03
- Average Figure Value = \$3.81
- Average # of Pieces = 7.25
- Rarest figures:
  - Sleepyhead
  - Lady Liberty
  - Clockwork Robot
  - Roman Soldier
  - Surgeon
  - Butcher
  - Genie

# Classic Alien

“The truth is around here somewhere!”

BL Code	# in box	Value	# of parts	# of extras	Face sides	Gender	# of sales	Strength	Creativity	Speed
col06-1	4	\$5.00	6	0	1	M	1353	2	4	4

Has also been called “Gray Alien” and “Retro Alien” in official LEGO materials.



Designed to resemble aliens of UFO sightings in popular culture.

The pyramids? These guys built them. The microwave? They invented it. Elvis? Got him right up there on the mothership. All of those totally out-there conspiracy theories about little gray men from outer space are absolutely 100% true – or at least, that’s what the Classic Alien believes. You see, he’s been out of communication with the home planet for a while (thanks to that whole Area 51 thing), and all of his recent news has come from what he’s read in supermarket tabloids and seen on the internet. Those reporters and bloggers really seem to know their stuff, so he figures they must have the real scoop. After all, if it’s not all true, then what’s he even doing here?

# Highland Battler

“They may take our bricks, but they’ll never take our imagination!”

BL Code	# in box	Value	# of parts	# of extras	Face sides	Gender	# of sales	Strength	Creativity	Speed
col06-2	5	\$2.94	7	0	1	M	928	5	2	4

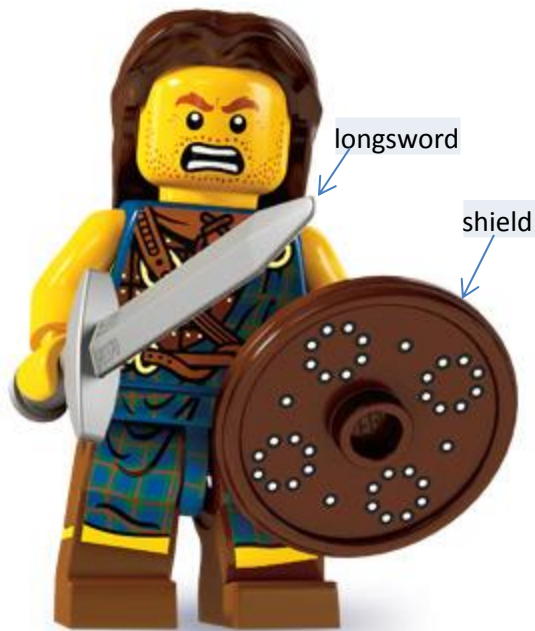

The Highland Battler is proud of his fighting skills, proud of his strength, and especially proud of his fine plaid kilt. He feels that he is upholding the history and traditions of his whole clan in every challenge he faces, from defending the Highlands to playing board games, and he accepts nothing less than glorious victory at each one.

He considers any kind of loss to be a crushing blow to his honor, and so he strives to be the very best at every competition imaginable, whether great or small. Most importantly, though, he always insists on winning by the rules. To the Highland Battler, there’s only one thing in the world worse than losing – and that’s being a cheater!

Quote is based on similar quote from William Wallace’s *A Scottish Rebel*, “They may take our lives but they will never take our freedom!”



# Sleepyhead

Rare

“Just five more minutes...”

BL Code	# in box	Value	# of parts	# of extras	Face sides	Gender	# of sales	Strength	Creativity	Speed
col06-3	3	\$4.44	6	0	2	M	1373	1	2	0



Ya-a-a-awn! Is it really time to get up already? The Sleepyhead isn't quite ready to face the morning yet. He was just having a totally awesome dream about adventuring in a magical world full of colorful knights with swords that shoot lightning...or was it the one about the time machine powered by historical hats?

Who can rise and shine when bed is so comfy and you've got your favorite teddy bear by your side? Don't worry; the Sleepyhead will be up in a minute. Maybe he'll just close his eyes and grab a quick nap first, though. After all, you can't get through the day without plenty of rest! Zzzzz....

Bio references the Knights' Kingdom II and Time Cruisers themes.



# Lady Liberty

Rare

“Give me your tired, your poor, your huddled Minifigures yearning to build free!”

BL Code	# in box	Value	# of parts	# of extras	Face sides	Gender	# of sales	Strength	Creativity	Speed
col06-4	3	\$5.17	8	0	1	F	1612	5	3	0



Lady Liberty is a symbol of creative freedom to all Minifigures, no matter their theme of origin. Holding her torch up high – and sometimes waving it around when she gets really excited – she is a beacon of inspiration to all who see her.

Lady Liberty protects against oppression of all kinds. Villains and tyrants may try to topple her, but she always stands tall (well, as tall as any Minifigure, anyway), stirring the hearts of patriotic citizens everywhere to build bigger and grander brick creations than ever before.

First minifigure to be based on a real world monument.

Quote is based Emma Lazarus' poem that is carved on the pedestal of the Statue of Liberty “Give me your tired, your poor / Your huddled masses yearning to breathe free...”

# Bandit

“Whaddya mean, I can’t have seven aces?”

BL Code	# in box	Value	# of parts	# of extras	Face sides	Gender	# of sales	Strength	Creativity	Speed
col06-5	5	\$2.60	8	0	1	M	1135	2	4	4



Lean, mean and bad-mannered, the black-clad Bandit is a notorious outlaw of the Old West. This despicable desperado is an expert at cattle-rustling, horse-stealing, claim-jumping and train-robbing, but he always ends up getting caught by the long arm of the law thanks to his one big weakness: he cheats at everything.

Whether he’s playing cards or trying to outride the sheriff, the Bandit always looks for the unfair and easy path to fortune. He’ll take secret shortcuts that get him stuck in cactus patches, swipe the fastest stallion in the county only to have it throw a shoe, and rig sharp-shooting contests that end with saloon signs crashing down on his head. As long as he keeps trying to cheat, this bad guy will never win!

# Flamenco Dancer

“Behold the blaze of el baile flamenco!”

BL Code	# in box	Value	# of parts	# of extras	Face sides	Gender	# of sales	Strength	Creativity	Speed
col06-6	4	\$2.30	6	0	1	F	541	1	3	3



The Flamenco Dancer lives for the fiery rhythm of flamenco. She knows every part by heart: the singing, the guitar, the clapping and most especially the dancing. Just follow the music as it winds through the streets and you're sure to find her dancing with her fan in hand long into the night.

The Flamenco Dancer is always looking for more ways to express her passion through dance. Recently, she has formed an unusual partnership with three other musical Minifigures: the **Maraca Man**, the **Punk Rocker** and the **Hula Dancer**. By combining their talents together, they're hoping to create a whole new kind of flamenco to show off to the world!

# Clockwork Robot

Rare

“Beep-boop! Who-wants-a-hug?”

BL Code	# in box	Value	# of parts	# of extras	Face sides	Gender	# of sales	Strength	Creativity	Speed
col06-7	3	\$4.39	6	0	1	M	1913	4	2	2



The Clockwork Robot just wants to be loved. He may have started out as a simple toy, but somewhere along the way his little ticking heart took on a life of its very own. Now that he can walk and talk and think (as long as somebody remembers to keep his key wound up), he's hoping to find his true place in the big LEGO® world.

But what does a Clockwork Robot do? He can walk around making beeping sounds, and he has lots of shiny buttons and dials, but he feels there must be more to life. He's tried copying some of the other Minifigures, but he kept falling off his horse, deep-sea diving made his gears rusty, and masked wrestling was definitely a big mistake. Maybe he'll just try hugging everybody he sees instead!

# Minotaur



“Wait, was it left at the next passage, or right?”

BL Code	# in box	Value	# of parts	# of extras	Face sides	Gender	# of sales	Strength	Creativity	Speed
col06-8	5	\$2.96	8	0	1	M	2582	5	1	4



Half Minifigure and half bull, the legendary Minotaur is said to make his home deep within a great, maze-like labyrinth that only the most brave or foolish of heroes dares to enter. And while that much is true, the rumor that the ferocious beast guards a fabulous treasure is not...in fact, he's only in there because he can't find his way out!

The thing is that the Minotaur is just terrible at directions. He used to have a map of the place, but he lost it somewhere and ever since, he's wandered around the labyrinth hoping to run into somebody helpful who can show him where the entrance is. Unfortunately, everyone that he's met so far either tries to fight him or runs away. Maybe it's the horns...or the axe...or the cow-breath?

# Leprechaun

“Sure, I’ll show you where my gold is hidden! Just close your eyes and spin around three times...”

BL Code	# in box	Value	# of parts	# of extras	Face sides	Gender	# of sales	Strength	Creativity	Speed
col06-9	4	\$2.96	9	0	1	M	1526	1	5	4



The jolly but mischievous Leprechaun loves to play pranks on anyone who comes looking for his famous pot of gold. He can appear with a wink and vanish with a nod, hop down a rabbit-hole or leap to the top of the tallest tree, and even transform into a talking animal if it will help him pull off a really fun practical joke on an unsuspecting treasure-hunter.

The Leprechaun once misplaced his pot of gold and tried his luck at being a shoemaker, but it just didn't work out. The problem was, almost no Minifigures actually wear shoes...and on most of the ones that do, they don't come off!



Fan  
Favorite

# Roman Soldier

MVP  
Price

Rare

“I’ll march anywhere, fight anyone, and build anything you command!”

BL Code	# in box	Value	# of parts	# of extras	Face sides	Gender	# of sales	Strength	Creativity	Speed
col06-10	3	\$9.85	7	0	1	M	871	5	3	3

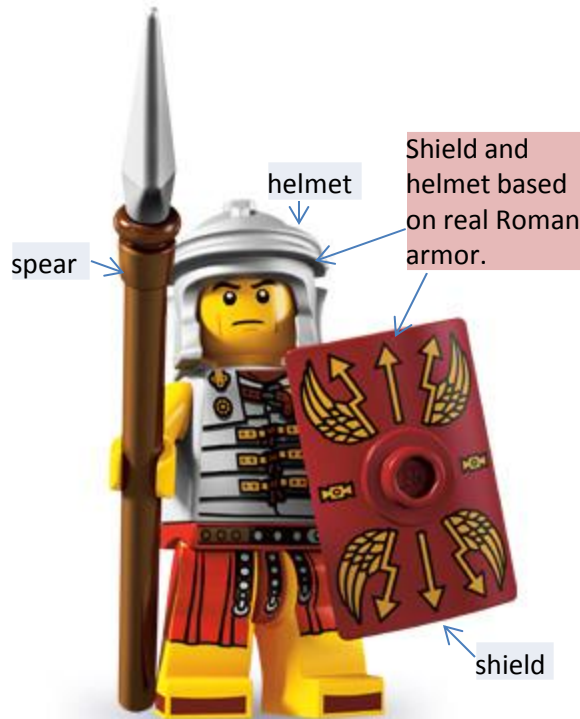

Ever since he was first assembled, the Roman Soldier has followed his orders without a moment's hesitation. Just tell him what you want done and he'll carry out your command right away, treating each mission as equally important no matter how tough (or silly!) it may be. The other Minifigures sometimes take advantage of this, so you may find the Roman Soldier hard at work doing the dishes, taking pets for walks and building aqueducts all over town, just because somebody else didn't want to get their own chores done. But he doesn't mind the extra work – according to him, that's what a Roman Soldier is for!

# Surgeon

Rare

“Some say laughter is the best medicine, but I say MEDICINE is the best medicine.”

BL Code	# in box	Value	# of parts	# of extras	Face sides	Gender	# of sales	Strength	Creativity	Speed
col06-11	3	\$3.50	7	0	1	F	750	1	3	4



Nothing distracts the ever-serious Surgeon when she's performing an important operation. She works with a level head and a steady hand despite any rock monster rumblings, dinosaur attacks or invasions by brain-sucking aliens that may be going on around her.

Then again, it's no surprise when you see who her patients are. Without the Surgeon's pioneering work, modern medicine wouldn't know how to mend a rock monster's lava gland, perform a tonsillectomy on a Triceratops, or stuff all of that brainpower back where it belongs. It all may seem a bit unusual, but to the Surgeon, a patient is a patient no matter the circumstances!

Description refers to Power Miners, Dino, and Alien Conquest themes.

# Skater Girl

“Who cares what anybody thinks? I skate for me!”

BL Code	# in box	Value	# of parts	# of extras	Face sides	Gender	# of sales	Strength	Creativity	Speed
col06-12	4	\$2.47	8	0	1	F	640	1	3	4



Some Minifigures skate for fame. Others skate for thrills. But for the Skater Girl, it’s all about having fun! It doesn’t matter what anyone else thinks about her skating skills as long as she can feel two things: the wind whipping through her streaked hair, and her custom-painted board beneath her feet.

But sometimes the more you try to avoid attention, the more of it you end up getting. Thanks to her carefree attitude, the Skater Girl has gained a huge fandom devoted to discussing all of her latest skateboarding tricks and stunts. But she doesn’t care – they can say whatever they want, and she’ll just keep on doing her own thing her own way!

# Intergalactic Girl

“No thanks needed. I’m just doing my part to make the spaceways safe!”

BL Code	# in box	Value	# of parts	# of extras	Face sides	Gender	# of sales	Strength	Creativity	Speed
col06-13	4	\$2.90	9	0	1	F	452	2	5	3

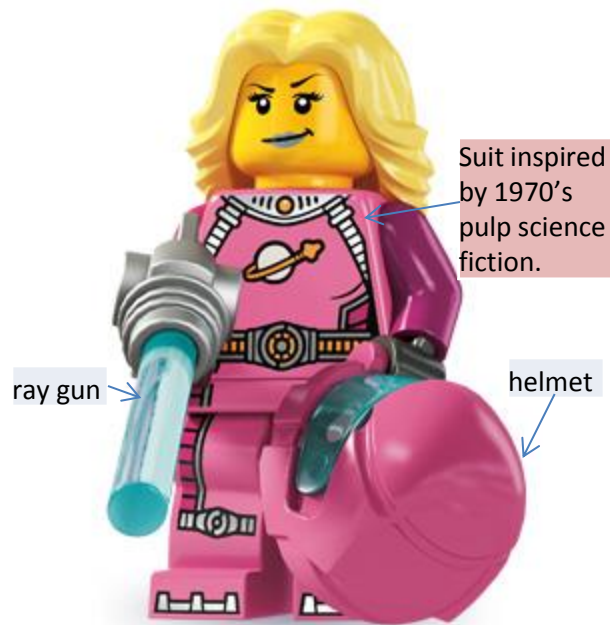

The name of the Intergalactic Girl is cheered by life forms on every inhabited planet, moon, space station and asteroid in the cosmos. As an interstellar adventurer, she and her daring outer-space exploits are the stuff of legend throughout the known universe, and even a few of the unknown bits, too.

With nothing but a quasar zapper, a pair of antigravity boots and a can-do attitude, the Intergalactic Girl has single-handedly saved solar systems from black holes, rescued civilizations from cosmic conquerors and captured entire fleets of Blacktron battle cruisers. She never has time to stay for the celebrations afterwards, though, because there's always another space crisis waiting just around the next nebula!

# Butcher

Rare

“Howdy! How about some meat?”

BL Code	# in box	Value	# of parts	# of extras	Face sides	Gender	# of sales	Strength	Creativity	Speed
col06-14	3	\$3.08	7	0	1	M	1608	4	2	3



The Butcher is a cheerful chap in his tidy hat and apron, always happy to chat about the weather or pass on the latest news from town. But no matter how a conversation with him starts, somehow it always ends up coming around to the subject of meat.

It's really no surprise; after all, it's the Butcher's very favorite thing in the entire world. Whether you're talking poultry or sausage, hamburger patties or a fresh T-bone steak, you'll never find anybody who knows more about meat. Ask around and you'll see!

# Mechanic

“Sure, I can fix that...but wouldn’t it be even cooler with a rocket engine?”

BL Code	# in box	Value	# of parts	# of extras	Face sides	Gender	# of sales	Strength	Creativity	Speed
col06-15	4	\$2.65	7	0	1	M	392	2	4	3

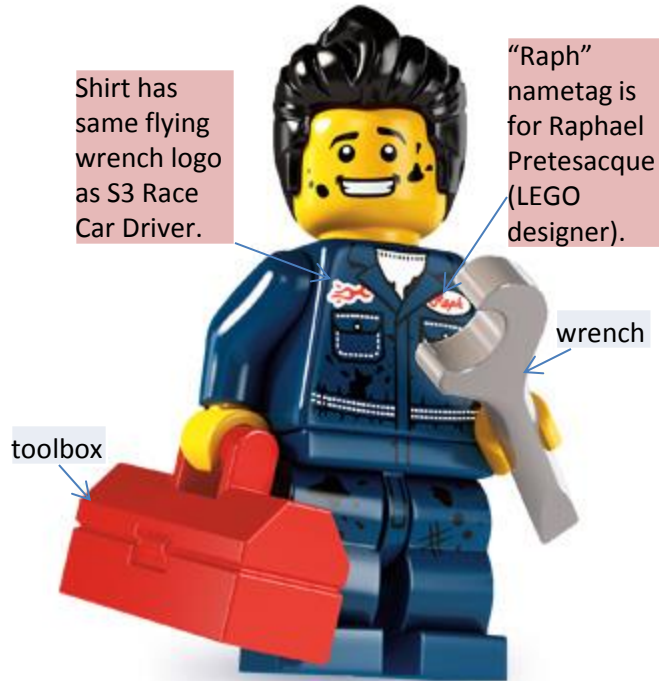

Nobody is better at quick repairs than the Mechanic. He can fix any dent, ding, rumble or rattle with his handy wrench and toolbox, and he doesn’t mind getting dirty in the process. No matter the problem, he’ll have your vehicle running as good as new in no time flat...but he never quite seems to know where to stop!

To the Mechanic, there’s no auto in the world that wouldn’t be improved by adding a couple of stylish fins, a fancy spoiler and a big engine on top of the hood. And while he’s at it, he might just put in a submarine propeller, some ejector seats, a couple of extra wheels and a booster rocket or three. If that’s what he does with a car, imagine what he’ll do with a spaceship!



# Genie

Rare

“I’ll grant your wish...your wish for bricks!”

BL Code	# in box	Value	# of parts	# of extras	Face sides	Gender	# of sales	Strength	Creativity	Speed
col06-16	3	\$3.81	7	0	1	M	1520	3	5	5



Rub the magic lamp and this friendly Genie will pop out to grant your wishes\*...as long as they have to do with LEGO® bricks! Want a big enough pile of pieces to build a perfect full-scale model of the Great Wall of China? No problem! Looking for that long-lost LEGO Castle set you left in the playground when you were 5 and never saw again? Your wish is his command!

There’s only one limitation on the Genie’s incredible magical powers: he doesn’t do instruction booklets. He’ll give you all the bricks you could possibly want, but it’s up to you to figure out what to do with them. Ask him why, and he’ll just tell you that building steps are another genie’s department!

(\*wish-granting requires use of imagination)

# Series 7 – May 2012

Avg price ea	Avg # of parts (not incl extras)	F count	M count	N count	# Sold last 6 mos	MVP Price Name	MVP Price
\$ 3.39	7.4375	5	11	0	9309	Bunny Suit Guy	\$5.13

LVP Price Name	LVP price	MVP Qty Name	MVP Qty	LVP Qty Name	LVP qty	Avg Set Price	Avg Case Price
Jungle Boy	\$ 2.43	Evil Knight	983	Viking Woman	312	\$ 54.16	\$200.79



# Series 7 Stats

## Genders

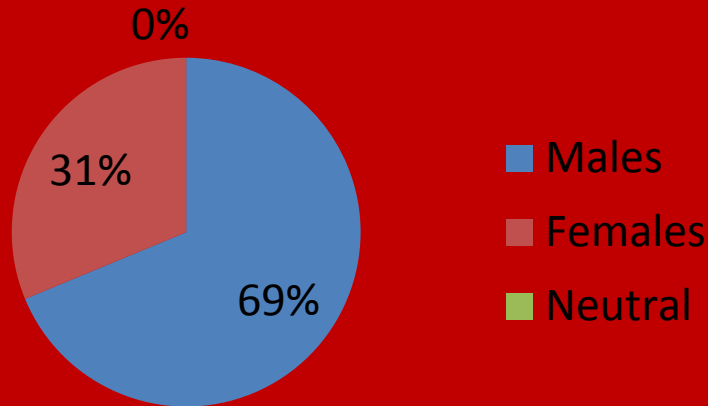

## Value

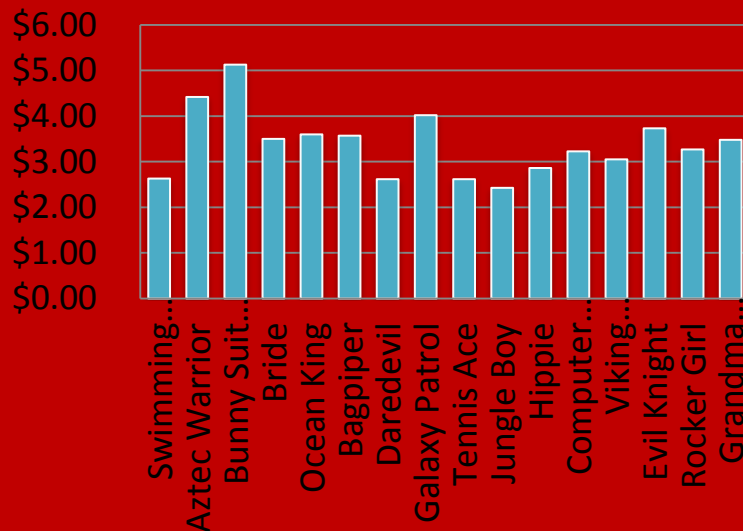

- Most Valuable = Bunny Suit Guy
- Most Popular = Evil Knight
- Least Valuable = Jungle Boy
- Least Popular = Viking Woman
- Average Set Value = \$54.16
- Average Figure Value = \$3.39
- Average # of Pieces = 7.4375
- Rarest figures:
  - Swimming Champion
  - Aztec Warrior
  - Bunny Suit Guy
  - Bride
  - Ocean King
  - Rocker Girl
  - Grandma Visitor

# Swimming Champion

Rare

“It’s all in the kicking!”

BL Code	# in box	Value	# of parts	# of extras	Face sides	Gender	# of sales	Strength	Creativity	Speed
col07-1	3	\$2.63	6	0	2	F	340	3	2	4



When you’re as accomplished a swimmer as the Swimming Champion is, you’ve got to work hard to find newer and bigger challenges for yourself. After all, once you’ve won the gold medal in every competitive swimming event around the world, what else is there to do but start making up your own extreme aquatic sports?

Her quest to find new ways to test her limits has taken the Swimming Champion from iceberg-pushing matches at the North Pole to penguin racing in Antarctica. She’s swum her way across every ocean, lake and sea you can name, and no one’s been able to beat her for time or distance. Some people say she must be part fish, but the **Ocean King** swears she isn’t...though he’s definitely her number one fan!

# Aztec Warrior

Rare

“No, you can’t have our gold! Go find your own!”

BL Code	# in box	Value	# of parts	# of extras	Face sides	Gender	# of sales	Strength	Creativity	Speed
col07-2	3	\$4.42	7	0	1	M	414	4	2	3



A mighty soldier of the sun, the Aztec Warrior is one of the fierce Eagle Knights of the legendary Aztec Empire. Protected by his feathered shield and beaked helmet, he battles for the glory of his empire from sunrise to sunset, never stopping for food or rest as long as there are enemies to capture and the sun shines bright in the sky.

And there certainly are plenty of enemies! For some reason, people are always trying to steal the empire’s gold. Sure, it’s pretty and you can make it into some nice, shiny weapons and armor, but the Aztec Warrior doesn’t really get what the big deal is with the stuff. Sometimes he wishes the invaders would only come at night so some other warriors could deal with them instead!

# Bunny Suit Guy

MVP  
Price

Rare

“What kind of noise does a bunny make, anyway?”

BL Code	# in box	Value	# of parts	# of extras	Face sides	Gender	# of sales	Strength	Creativity	Speed
col07-3	3	\$5.13	7	0	1	M	595	1	2	1

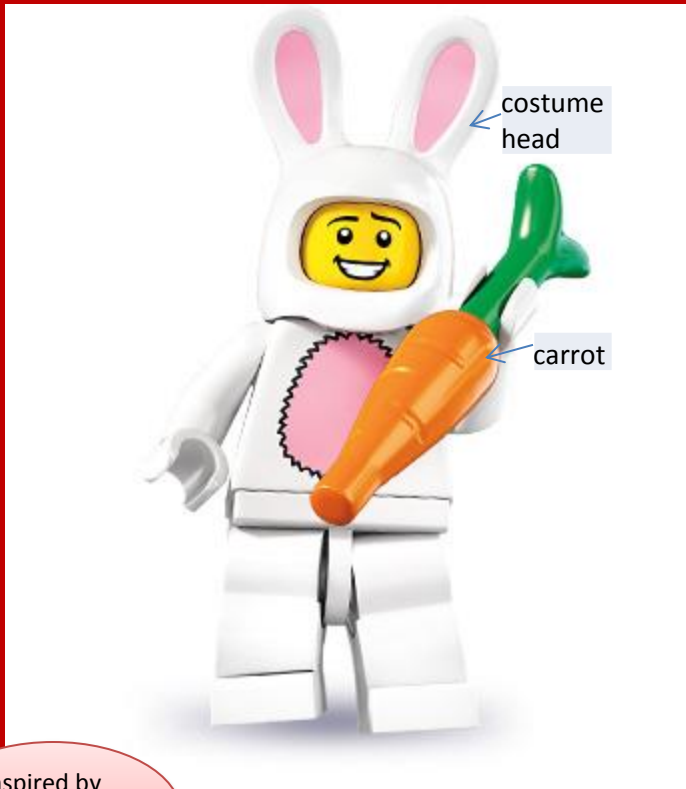

Hippity-hop! Hippity-hop! Here he comes, hopping down the lane – it’s the happy, jolly Bunny Suit Guy! He’s got the whole outfit: the fuzzy white costume, the tall flappy ears, and even a big orange carrot to carry around. And what made him decide to dress up like a bunny? He has absolutely no idea!

As far as the Bunny Suit Guy knows, he’s always been the Bunny Suit Guy. He’s not entirely sure what a Bunny Suit Guy is or does, but he’s determined to do the best job of it that he possibly can. As far as he can tell, that means hopping around, eating carrots and making people smile. Fortunately, the Bunny Suit Guy is good at all three!

Inspired by Easter Bunny costumes.



# Bride

“I do!”

Rare

BL Code	# in box	Value	# of parts	# of extras	Face sides	Gender	# of sales	Strength	Creativity	Speed
col07-4	3	\$3.50	11	1	1	F	576	1	3	2



Has the most pieces of any LEGO minifigure (counting extra flower piece).

The Bride has been busy getting ready for her big day! All of the invitations have been sent out, the floral arrangements are arranged, the banquet is prepared and the facilities are perfect. The cake has just the right number of layers, her gown and veil are as beautiful as she always dreamed they would be, and the groom looks so handsome in his tuxedo and bow tie.

Everything is ready...now the wedding just needs to go off without any problems! What if a guest is allergic to the salad, or somebody drops the cake, or a swarm of bees goes after the flowers, or alien attack-bots crash in the middle of the ceremony? There's so much that could go wrong today – here's hoping it all works out!

# Ocean King

Rare

“Beware the wrath of the lord of the seas – and no splashing in the pool!”

BL Code	# in box	Value	# of parts	# of extras	Face sides	Gender	# of sales	Strength	Creativity	Speed
col07-5	3	\$3.60	7	0	1	M	536	4	3	4



Ruler of a vast underwater kingdom, the Ocean King is the master of all the world’s seas. His enchanted trident gives him absolute control of the waves and tides, and woe to any sailor who dares to anger him! Fortunately, he’s easily appeased by rare treats from the surface world, and a cookie or pizza slice (no anchovies, please!) left in just the right tide pool will usually ensure a smooth and tranquil ocean voyage.

Just make sure it’s the proper kind of gift. The Ocean King doesn’t take kindly to people who drop litter into his deep blue domain, and he’s been known to summon raging storms and whirlpools if he’s having a bad day, or even just a mild headache. It might sound like an overreaction, but you try wearing a crown made of pointy gold shells all the time and see how calm you feel!

# Bagpiper

“And here’s a little ditty my ol’ granddad taught me!”

BL Code	# in box	Value	# of parts	# of extras	Face sides	Gender	# of sales	Strength	Creativity	Speed
col07-6	4	\$3.57	7	0	1	M	822	1	4	2



Created in honor of Tara Wilke's (LEGO designer) grandfather who grew up in Scotland.

Bagpiping runs in the Bagpiper's blood. His father played the bagpipes, and so did his grandfather, his great-grandfather and their grandfathers before them, all the way back to the day the beloved musical instrument first arrived in Scotland.

He's played his pipes for weddings, marches, wrestling matches and haggis-eating contests (he's also played them at chess tournaments and libraries, but for some reason his enthusiastic performances didn't go over so well then). Other musical styles may come and go, but the Bagpiper knows in his heart that the bagpipes will last forever!

# Daredevil

“Stunts are easy...it’s all the other stuff that takes nerves of steel!”

BL Code	# in box	Value	# of parts	# of extras	Face sides	Gender	# of sales	Strength	Creativity	Speed
col07-7	4	\$2.62	8	0	2	M	777	2	3	4



No matter the stunt, no matter the danger, the dashing Daredevil risks it all for each and every spectacular show. Flaming hoops, long-distance canyon jumps and giant stomp-powered launchers are a breeze for this fearless fellow, who always keeps his cool in even the most perilous situations. It’s the normal, everyday situations that give him pause. Driving a motorcycle at full speed up a ramp and over a dozen garbage trucks is no problem – but buying stamps at the post office? Yikes! He’ll waterski blindfolded through a school of snapping cyber-sharks, but don’t ask him to find the beans at the grocery store, or he’ll run away screaming. It looks like the daring Daredevil has definitely picked the right line of work!

# Galaxy Patrol

“No outer-space menace escapes the Galaxy Patrol!”

BL Code	# in box	Value	# of parts	# of extras	Face sides	Gender	# of sales	Strength	Creativity	Speed
col07-8	5	\$4.02	7	0	2	M	735	4	2	4



The members of the Galaxy Patrol are an elite squadron of deep-space heroes who are dispatched to the most remote and dangerous sectors of the galaxy to fight cosmic evil wherever it appears. With their heavy-duty space armor and helmet-mounted tactical computers, they’ve got the gear, the training and the attitude to always get the mission done.

To join the Galaxy Patrol, you’ve got to be as tough as space-nails, able to resist the mind-control powers of a Pluuvian Brain-Beast, and capable of holding your breath in vacuum for at least 42 quarkoids. Most recruits wash out, but the ones that are left are the best of the best, ready to defend the universe from interstellar threats of any and every kind – no matter how many eyes, claws and tentacles they may have!

Bio refers to Alien Conquest theme (Pluuvian Brain-Beast) and *The Hitchhiker’s Guide to the Galaxy* book (holding breath). Also called “Space Marine” in official LEGO material.

# Tennis Ace

“Wham! And there it goes!”

BL Code	# in box	Value	# of parts	# of extras	Face sides	Gender	# of sales	Strength	Creativity	Speed
col07-9	4	\$2.62	6	0	1	M	582	5	2	4



Some minifigures train hard all their lives to be good at their chosen sport...and then there's the Tennis Ace. Where other tennis players might wait for the ball to come to them, he hurls himself toward it with all his strength, swinging his racket around wildly. Instead of carefully aiming the ball, he hits it in any random direction and hopes it lands inside the court's lines.

It's not the most traditional way to play, and yet somehow it manages to work. Despite a complete lack of strategy, patience and timing, the Tennis Ace just keeps moving up in the rankings. Maybe it's luck, maybe it's well-hidden natural talent and maybe it's sheer gusto, but whatever it is, it sure does drive the other players crazy when he wins!



# Jungle Boy

“Oooo-aaaa-oooo-aaaa-ouch!”

BL Code	# in box	Value	# of parts	# of extras	Face sides	Gender	# of sales	Strength	Creativity	Speed
col07-10	5	\$2.43	7	1	1	M	436	5	1	4



Inspired by  
Tarzan.

Growing up in the jungle isn't as easy as you might think – just ask the Jungle Boy! Being raised by a family of chimpanzees seems like a lot of fun, but you sure do end up eating a lot of bugs. And swinging around on vines sounds great until you realize how slippery they are and how far down the ground is. Yep, the jungle life might be full of fresh air and freedom, but it's also full of scrapes and bruises a-plenty.

It's neat to be able to speak the languages of the beasts, but it's not like they have anything really interesting to say...plus, talking to a leopard doesn't keep it from trying to eat you. And do you know how hard it is to check your text messages way out here? All things considered, after a few more nights of sleeping in trees with nothing but a loincloth for warmth, the Jungle Boy might just start thinking about moving back to civilization!

# Hippie

“Make LEGO® models, not war!”

BL Code	# in box	Value	# of parts	# of extras	Face sides	Gender	# of sales	Strength	Creativity	Speed
col07-11	4	\$2.86	9	1	1	M	365	1	3	2

Quote is the same as what's printed on this sticker from LEGO set 10220.



bouquet



Inspired by the 1960's peace-loving movement.

The friendly, good-natured Hippie loves everything in the entire world. Rain and shine, day and night, puppies and kittens – they all bring a happy smile to his face. With a fashion sense that hasn't changed since the Sixties, he never stays in the same place for long, preferring to roam across city and countryside alike, stopping only to smell the flowers and spread his simple message of peace, love and LEGO bricks.

As a pioneer of the Free-Building movement, the Hippie rejects all building instructions. Instead, he believes that true creativity lies in making a big pile of your bricks and putting them together in whatever way most inspires your imagination. According to him, it's the ultimate groovy way to reveal your true inner soul as a builder!

Bio refers to Alien Conquest theme (Pluuvian Brain-Beast) and *The Hitchhiker's Guide to the Galaxy* book (holding breath). Also called "Space Marine" in official LEGO material.

# Computer Programmer

“Hello, World.”

BL Code	# in box	Value	# of parts	# of extras	Face sides	Gender	# of sales	Strength	Creativity	Speed
col07-12	4	\$3.23	7	0	1	M	659	1	3	4



Other computer whizzes can argue all they like about what kind of computer or operating system is the best one – the Computer Programmer knows that the only way to be a real expert is to master all of them. He knows everything there is to know about computers and how to use them, from the biggest old-time mainframes to the tiniest next-generation nanotech prototypes, and he’s always glad to share his expertise with anyone who needs his help – which is just about everyone eventually! He can debug a server in ten seconds flat, track down and wipe out even the toughest viruses, recover data from completely melted hard drives, and yes, he will help you set up your e-mail signature. In his spare time, he programs his own video games, catches up on the latest posts in his favorite web forums, and hangs out with his pet robo-cat. When you’re a skilled Computer Programmer, the future is always today!

Quote is traditionally used to illustrate to beginners the most basic syntax of a programming language.

# Viking Woman

“Now that the fight is over, it is time to sing!”

BL Code	# in box	Value	# of parts	# of extras	Face sides	Gender	# of sales	Strength	Creativity	Speed
col07-13	4	\$3.05	9	0	2	F	312	5	3	3



Inspired by the Valkyrie in Norse mythology.

When danger threatens the village, it's up to every Viking to help out, and the Viking Woman has proven herself to be one of the greatest warriors of them all. Stalwart and strong, she stands with sword and shield raised, ready to face and fight off any army or monster – or army of monsters – that dares to attack the wooden walls.

Even after the battle, the Viking Woman's talent continues to shine. As the keeper of the village's lore, she knows all the great poems and ballads of her people, and can belt them out in truly impressive song. With each battle won, she adds another verse, so that the triumphs of her clan will be remembered down throughout history!

# Evil Knight

MVP  
Qty

“Surrender...to whichever boss I’m taking orders from today!”

BL Code	# in box	Value	# of parts	# of extras	Face sides	Gender	# of sales	Strength	Creativity	Speed
col07-14	5	\$3.73	8	0	1	M	983	5	2	2



The Evil Knight loves nothing better than looting, pillaging and laying waste to peaceful kingdoms. He’s worked for all of the big baddies over the years, from Basil the Bat Lord to Cedric the Bull. He even once spent a memorable summer as one of Vladek’s mystical Shadow Knights, and was delighted that he got to keep his glowing red eyes afterwards.

Some bad guys take up villainy for money, and others for power or land, but the Evil Knight just likes being a wicked henchman. As long as he has a suit of spiky black armor, a sword and orders to cause trouble for a noble king or an innocent village, he’ll be happy to smash things up until somebody tells him to stop. In fact, he’s been part of so many evil armies that he sometimes forgets who he’s working for at the moment!

Bio references Vladek from Knights’ Kingdom II, Basil the Bat Lord from Fright Knights, and Cedric the Bull from Knights’ Kingdom. Also called “Dark Knight” in official LEGO material.



# Rocker Girl

Rare

“I’m the best and I know it!”

BL Code	# in box	Value	# of parts	# of extras	Face sides	Gender	# of sales	Strength	Creativity	Speed
col07-15	3	\$3.27	6	0	1	F	339	1	4	3

A similar but different version of this Minifigure came in the Rock Band Minifigure Accessory Set 850486.



Inspired by rock style of late 1970s, early 1980s. First official female musician minifigure.

Whatever you may say about the punky, pink-haired Rocker Girl, you can’t ever call her humble! From her clothes to her music, she goes through life with complete confidence in herself. She knows she looks and sounds awesome up there on stage with smoke and lasers flashing all around, and she lives for the way the crowd roars with excitement when she starts playing that next power chord.

The Rocker Girl’s unshakeable self-confidence has always been her greatest strength. No matter what troubles she faces – cancelled shows, electrical failures and bad cases of rockin’ pneumonia – she always powers right on through, knowing that her next performance will be the greatest one yet. And the best thing of all is that she’s right!



# Grandma Visitor

Rare

“Tra-la-la!”

BL Code	# in box	Value	# of parts	# of extras	Face sides	Gender	# of sales	Strength	Creativity	Speed
col07-16	3	\$3.48	7	0	1	F	357	1	3	2



Inspired by  
Little Red  
Riding Hood.

The sweet little Grandma Visitor is skipping through the woods to pay a call on her dear old granny. With her fine red hood and a basket full of tasty treats, she's sure she won't run into any wicked wolves...or bands of forest bandits...or giant spiders...or nasty ogres...say, what was that noise over there behind that tree?

Goodness, is that a raincloud up in the sky? Maybe this isn't the very best day for a stroll outdoors. The woods do seem a little chilly, and it would be such a shame if she were to catch a cold. Besides, her grandmother has a whole pantry full of food already, not to mention a brand-new microwave oven. Yes, staying inside today sounds like a very good idea. She'll try again tomorrow – and next time, she'll bring some friends along for back-up!



# Series 8 Stats

## Genders

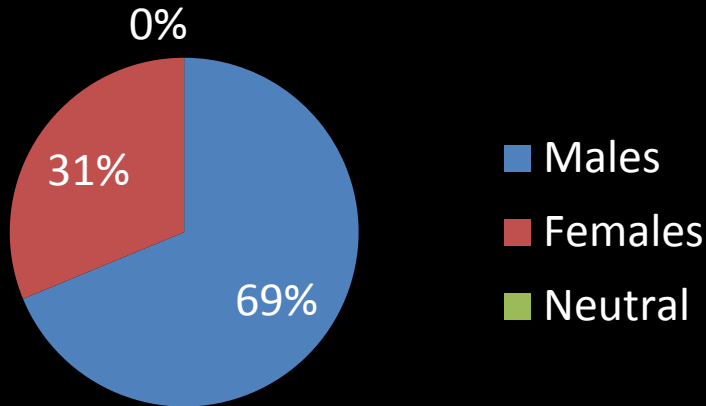

## Value

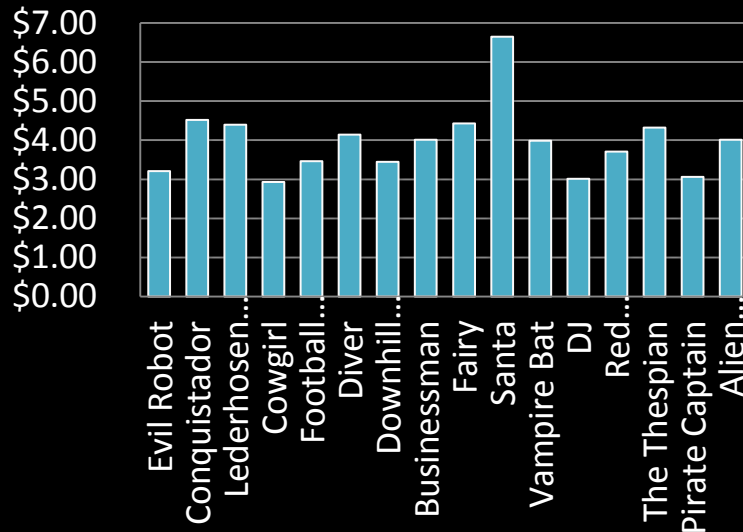

- Most Valuable = Santa
- Most Popular = DJ
- Least Valuable = Cowgirl
- Least Popular = Businessman
- Average Set Value = \$63.30
- Average Figure Value = \$3.96
- Average # of Pieces = 7.4375
- Rarest figures:
  - Lederhosen Guy
  - Diver
  - Downhill Skier
  - Businessman
  - Fairy
  - The Thespian
  - Alien Villainess

# Evil Robot

“Not computing does not build!”

BL Code	# in box	Value	# of parts	# of extras	Face sides	Gender	# of sales	Strength	Creativity	Speed
col08-1	5	\$3.21	8	0	1	M	415	3	1	2

Created as a substitute for rare Series 1 robot for fans. Compare their quotes!

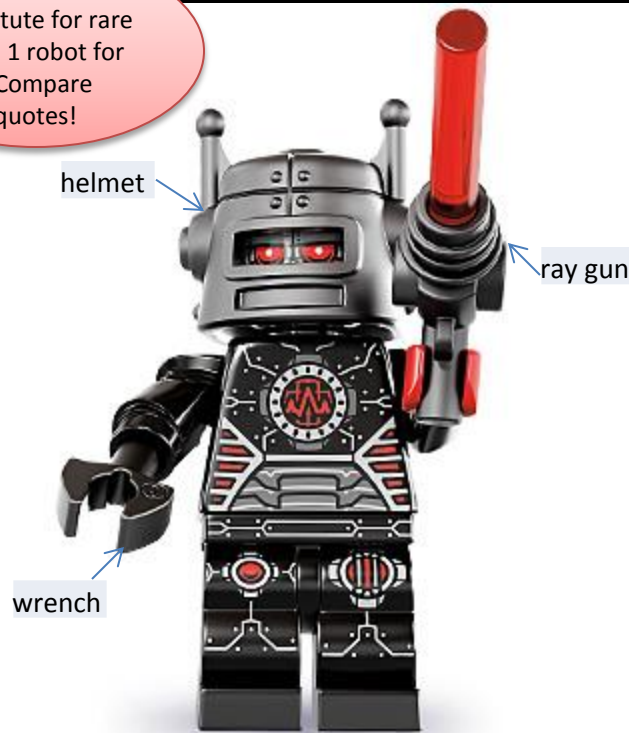

Everything that the **Robot** does, the Evil Robot tries to do the opposite. If the **Robot** spends all his time seeking out bricks and building giant towers out of them, then the Evil Robot dedicates himself to taking them apart and scattering the bricks everywhere – under beds, inside shoes, beneath fridges and anywhere else they’ll be hard to find.

The Evil Robot’s single-minded drive to be the **Robot**’s opposite does have certain flaws. Since the **Robot** walks forwards, the Evil Robot is determined to walk backwards everywhere he goes. The **Robot** is a hard worker, so the Evil Robot tries to be as lazy as possible. Despite all this, villains keep recruiting him to help out with their bad-guy schemes. It’s probably because he looks so cool, but they usually learn pretty fast that having an evil robot on your side isn’t always as useful as it sounds!

- The Evil Robot is the author of the bestselling book *How I broke the World Record for Messing up a Room in under 3 Minutes*.

# Conquistador

“Excuse me, but do you happen to have any gold?”

BL Code	# in box	Value	# of parts	# of extras	Face sides	Gender	# of sales	Strength	Creativity	Speed
col08-2	4	\$4.52	8	0	1	M	392	3	4	3

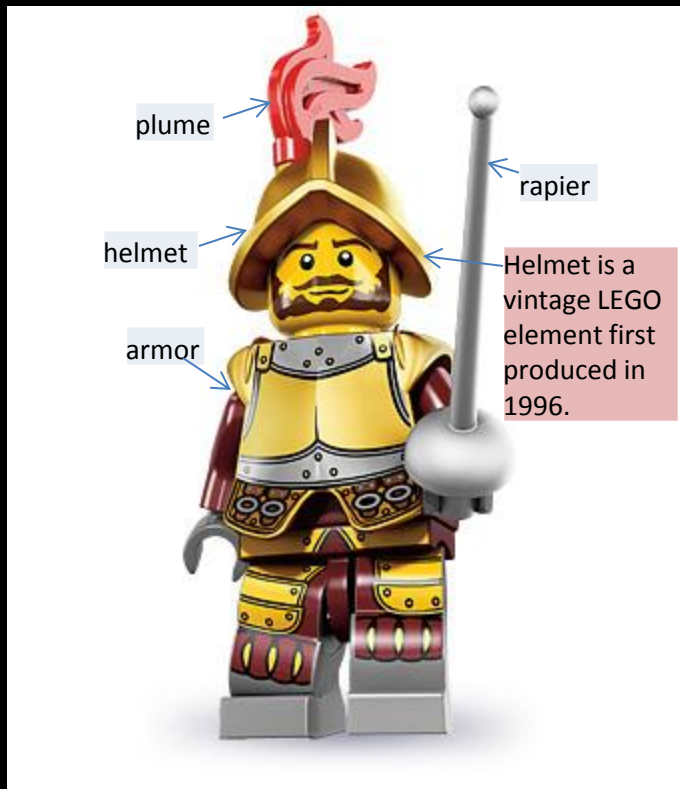

The Conquistador likes gold. REALLY likes gold. It's not so much about the wealth; he just thinks that it looks really good, and he'd like all of his stuff to be made out of it. If he had his way, he'd be living in a solid gold house, taking a nice bath in a gold tub full of golden coins. And the towels and shampoo would be gold, too.

The Conquistador has traveled all across the world in search of gold, but he hasn't had a lot of luck so far. For some reason, the people he meets always want to keep theirs, which seems pretty selfish to him – especially that **Leprechaun**, who just up and disappeared. Fortunately, he's heard about this newly-discovered place called the Aztec Empire. He figures he'll stop by there next and see if they've got any gold they don't mind sparing!

- Apart from gold, the Conquistador's favorite hobby is baking garlic bread. In his gold oven.



# Lederhosen Guy

Rare

“Hello! Do you like lederhosen?”

BL Code	# in box	Value	# of parts	# of extras	Face sides	Gender	# of sales	Strength	Creativity	Speed
col08-3	3	\$4.40	7	1	1	M	288	2	3	2

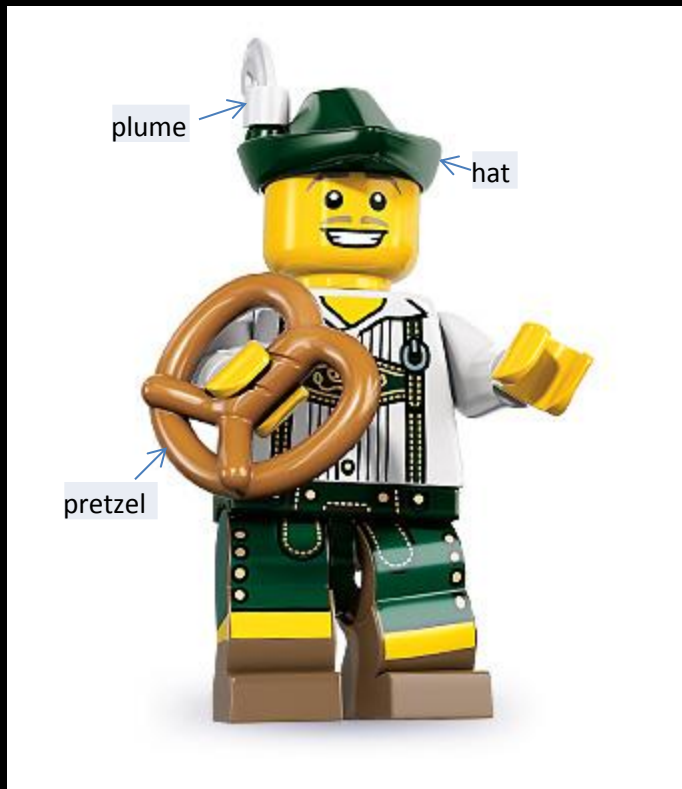

The Lederhosen Guy is extremely proud of his fine leather breeches. In fact, there's probably no one else around who's quite so fond of lederhosen. That's how you become known as the Lederhosen Guy, instead of just some guy who happens to wear lederhosen!

The Lederhosen Guy really is a giant fan of lederhosen. He goes to lederhosen conventions, subscribes to lederhosen magazines, and even writes a lederhosen blog. He also enjoys attending cultural festivals with his friends the **Highland Battler** and the **Bagpiper**. They may not share his love of lederhosen, but at least they agree that it's nice to feel the breeze on their knees!

- Lederhosen Guy has a special care kit for his hosen that includes ultrasonic hangers, nano leather cleaner and lavish embroidery applications.



# Cowgirl

“Ain’t nobody quicker’n me, pardner!”

BL Code	# in box	Value	# of parts	# of extras	Face sides	Gender	# of sales	Strength	Creativity	Speed
col08-4	4	\$2.93	6	0	1	F	255	5	3	5

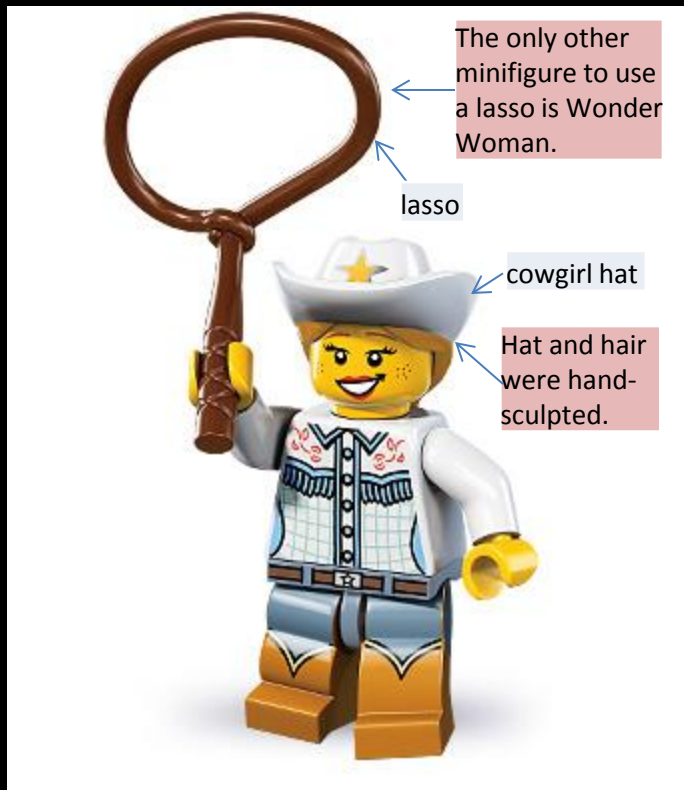

The rootin', tootin' Cowgirl is the fastest hand in the Wild West with a lasso. Whether she's pulling a stuck calf out of a ravine or rounding up that rascally **Bandit** for the fourteenth time this week, she can throw her rope quicker than anything, and catch whatever she's aiming at, too.

With the help of her lasso, the Cowgirl has been known to stop a charging bison, hoist the broken end of a bridge across a canyon, knock a water tower down to put out a barn fire, and set a runaway locomotive back on its tracks. About the only thing she hasn't been able to do with it so far is help the **Cowboy** track down his missing horse...but she sure aims to try!

- The Cowgirl once welded a replica of the Empire State building from used horseshoes. With her bare hands.

# Football Player

“Bring it on! I’m ready for anything!”

BL Code	# in box	Value	# of parts	# of extras	Face sides	Gender	# of sales	Strength	Creativity	Speed
col08-5	4	\$3.46	8	0	1	M	352	5	3	5



The Football Player wants to make sure that he never lets his team down. That’s why he trains for every situation that could possibly affect the outcome of a game, no matter how strange or unlikely. It might make the other players look at him a little funny, but he knows it’s always best to be fully prepared.

He trains in snowshoes, because they might have to play during a blizzard in Antarctica. He trains in scuba gear just in case they have a game underwater. He trains in math, physics and history to make sure he can calculate interception angles, tackling speed and battlefield (or football field) strategy. The Football Player knows that all his hard training will pay off some day, and when it does, he’ll lead his team to awesome victory!

- The Football Player had an imaginary friend named Dr. Watson when he was a child. He was a crazy scientist.

# Diver

Rare

“There’s always something new another hundred fathoms down.”

BL Code	# in box	Value	# of parts	# of extras	Face sides	Gender	# of sales	Strength	Creativity	Speed
col08-6	3	\$4.14	8	0	1	M	275	5	4	2

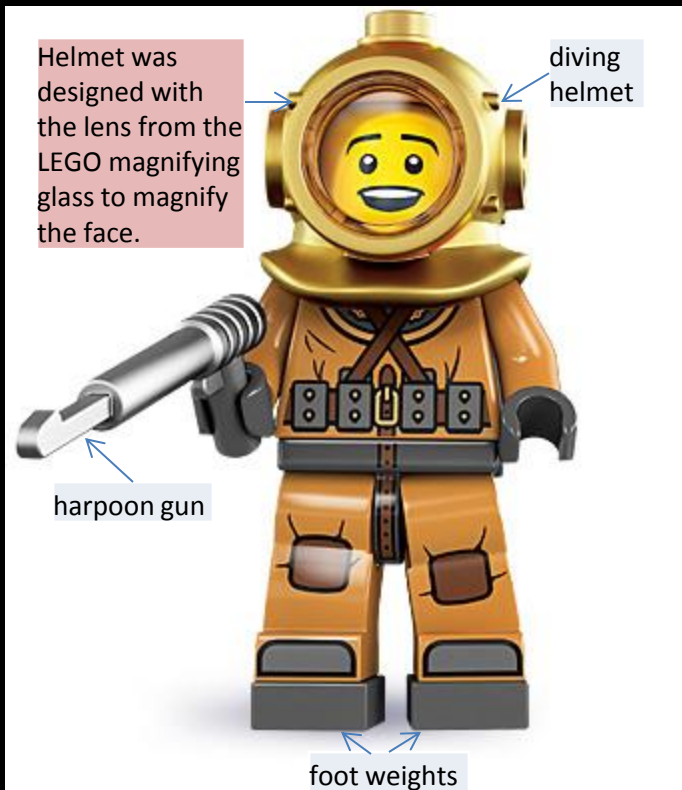

If he could, the Diver would spend his entire life beneath the sea. He’s a born explorer, but instead of climbing mountains or looking for lost valleys, he’s dedicated his life to plumbing the ocean depths in search of new discoveries and the answers to old mysteries.

Thanks to his weighted belt and boots, he can spend countless hours wandering through deep-sea trenches (as long as someone up top keeps pumping air into his diving hose) or hunting for shipwrecks (which aren’t hard to find when the **Pirate Captain** is around). He isn’t afraid of sharks or giant squids. Even the grumpy **Ocean King** considers him a friend, and has been known to ask the Diver to take care of his pet catfish when he goes out of town. To the Diver, the deep blue sea is the real final frontier!

- The Diver is working with top engineers to create the world’s first deep sea Dive In movie theater.

# Downhill Skier

Rare

“Don’t worry – it’s all downhill from here!”

BL Code	# in box	Value	# of parts	# of extras	Face sides	Gender	# of sales	Strength	Creativity	Speed
col08-7	3	\$3.45	9	0	1	F	264	5	4	5

Features new Friends colors.



The Downhill Skier is the world’s biggest optimist. No matter what big or little things may go wrong, she’s always cheerfully certain that the worst is over and everything will get better soon. And thanks to her positive outlook on life, it generally does!

Life, to the Downhill Skier, is just like a snow-covered mountain. There may be twists and turns on the way down, or hidden obstacles lurking just beneath the powder, but as long as you keep your knees bent, your poles straight and both eyes on where you’re going, you’re sure to get there all right in the end. Oh yeah, and it’s a good idea to watch out for trees!

- The Downhill Skier once outran a snow leopard. On foot.

# Businessman

Rare

“Me? Why, I’m just a simple businessman.”

BL Code	# in box	Value	# of parts	# of extras	Face sides	Gender	# of sales	Strength	Creativity	Speed
col08-8	3	\$4.01	7	0	1	M	244	3	3	3



It must be stated from the outset that the Businessman is simply an ordinary office worker. He is emphatically not, for example, a highly-trained secret agent who goes on daring undercover missions on behalf of the Crown, traveling under a humble guise in order to thwart the plots of mad scientists and evil masterminds all around the globe.

The Businessman’s bowler hat is most certainly not packed with hi-tech devices ranging from sophisticated listening gear to a deployable grappling line. Likewise, his perfectly normal briefcase does not contain a hidden microcomputer, and his newspaper is not a well-camouflaged data-pad with a remote satellite uplink. Nor do his glasses allow him to see in the dark or magnify distant objects a thousandfold. No, he’s just a regular, everyday businessman, and any rumors to the contrary should be strictly ignored.

- The Businessman absolutely does not have the Queen’s number on speed dial.



# Fairy

Rare

“Now, what was it you wanted? A quarter for your carriage, or a tooth turned into a pumpkin?”

BL Code	# in box	Value	# of parts	# of extras	Face sides	Gender	# of sales	Strength	Creativity	Speed
col08-9	3	\$4.43	8	0	1	F	304	2	4	4

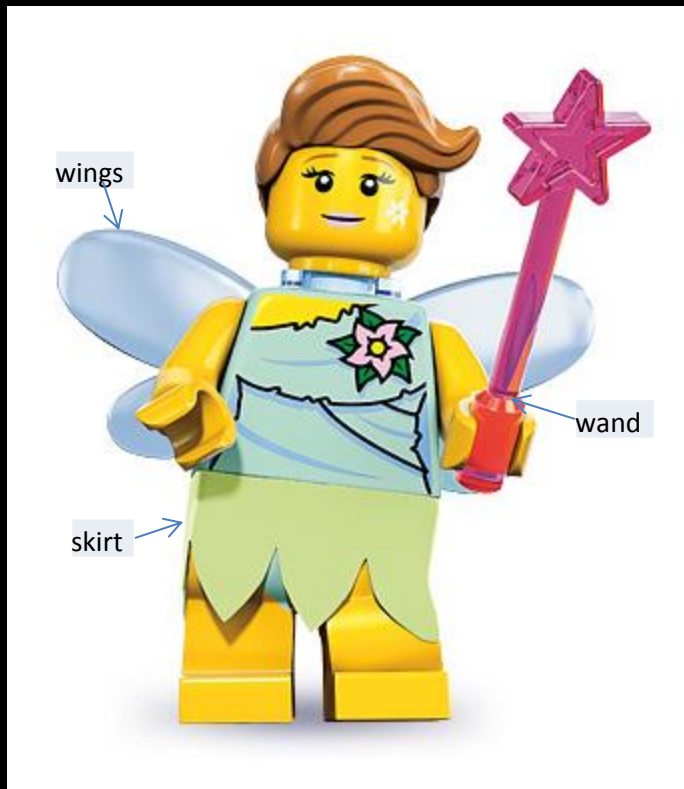

To say that the well-meaning Fairy is a little bit confused would be an understatement. She spends so much time flying to and fro (not to mention up, down, over and under) that she occasionally gets her thoughts a little bit jumbled-up. And she's just so carefree that she's even forgotten what kind of fairy she's supposed to be!

Is she a fairy godmother? A tooth fairy? One of those fairies who flits around meadows making dewdrops appear and flowers bloom? She tries being all of them, but she keeps mixing up what she's supposed to do. She's granted wishes to frogs (they wanted flies), left glass slippers under pillows (fortunately, they were very strong slippers) and transformed rocks into handsome princes (they mostly just sat around). Fortunately, thanks to the laws of fairy magic, no matter how mixed-up she may get – with a wave of her magic wand and a flutter of her wings, there's always a happy ending!

- The Fairy also works as a beta field tester of cutting edge navigation and tracking software.



# Santa

“Ho ho ho!”

MVP  
Price

BL Code	# in box	Value	# of parts	# of extras	Face sides	Gender	# of sales	Strength	Creativity	Speed
col08-10	4	\$6.65	7	0	1	M	259	3	5	3

The first official LEGO Santa Claus minifigure.



Also came in the 2013 City Advent Calendar 60024.

Rumor has it that a legendary minifigure known as Santa comes flying through the sky on his sleigh to give out shiny new bricks to anyone who needs to get some building done. Then, as soon as he's done, he's off on his way again with a belly-shaking laugh.

But who is this jolly old man of mystery? He's supposed to live up at the North Pole, but the LEGO® Arctic team never reported running into him during their millennial expedition. And where does he get all of those bricks, if not at the LEGO factory in Denmark? The world may never know for sure!

Bio mentions the Arctic theme and the LEGO factory in Denmark.

- Rumors about Santa working at LEGO® have never been confirmed. They haven't been denied either.

# Vampire Bat

“What a lovely day!”

BL Code	# in box	Value	# of parts	# of extras	Face sides	Gender	# of sales	Strength	Creativity	Speed
col08-11	4	\$3.99	5	0	1	M	413	2	3	5



The clever and stealthy Vampire Bat may be his monster master's chief hench-bat, but he isn't entirely thrilled by wicked schemes to eclipse the sun and plunge the world into eternal darkness. After all, he might be one of the children of the night, but that doesn't mean he wants to spend all his time there!

In fact, the Vampire Bat actually loves being out in the daylight. Sunny days at the beach are his idea of perfection (though he does get a lot of sand in his fur and it's not easy to see through the glare when your eyes are so well-adapted to the dark). Now that there are a bunch of human monster-fighters trying to foil his master's plans, he's secretly rooting for them to win!

Bio references the Monster Fighters theme. Lord Vampyre is his boss. Man-bats are cousins.

- The Vampire Bat recommends that you brush your teeth three times a day to keep them shiny.

# DJ

MVP  
Qty

“You haven’t heard anything yet!”

BL Code	# in box	Value	# of parts	# of extras	Face sides	Gender	# of sales	Strength	Creativity	Speed
col08-12	5	\$3.01	7	0	1	M	512	2	4	3



The DJ is the number-one disc jockey in town. Call in with a request for a song, a band or a style of music and he’ll not only play it, but tell you everything you could want to know about it, too. Even though he lives in the era of CDs and MP3s, he’s got a deep love for classic rock ‘n roll on vinyl, and even keeps complete collections of some of his favorite artists on his shelves at home.

The DJ’s favorite fellow minifigure is the **Disco Dude**. They may not share all of the same musical tastes, but he’s got to admit that the guy really knows how to dance. That’s why he’s seriously considering launching a disco hour on his show – at least on a trial basis!

- The colors on the DJ’s shirt are food stains that he just circled with a marker. Do you know how hard it is to DJ and eat takeaway at the same time?

# Red Cheerleader

“Gimme an even louder L, E, G and O! All right!”

BL Code	# in box	Value	# of parts	# of extras	Face sides	Gender	# of sales	Strength	Creativity	Speed
col08-13	4	\$3.71	7	0	1	F	291	4	5	4



While totally proud of her home team and wanting to do all she can to cheer the players on, the Red Cheerleader is also extremely competitive with her rivals on other cheer squads. Whatever the opposing team’s cheerleaders do, she feels like her squad needs to do it even bigger, better, and with more gusto.

Sometimes that leads her to go a little over the top with the cheering displays she puts together. It all started simply enough, with synchronized cartwheels and the occasional human pyramid. But that led to acrobatics...and then fireworks...and then parade floats...and then they hired that skywriter jet...and before her squad knew it, more people were coming to watch the cheering than the game!

Compare her quote with the S1 Cheerleader’s.

- The Red Cheerleader has a great retirement plan. She plans to never retire.

Fan  
Favorite

# The Thespian

Rare

“To build, or not to build...that’s not a hard question at all!”

BL Code	# in box	Value	# of parts	# of extras	Face sides	Gender	# of sales	Strength	Creativity	Speed
col08-14	3	\$4.32	7	0	2	M	248	3	5	3

Has a double-sided head to show the range of his acting skills.

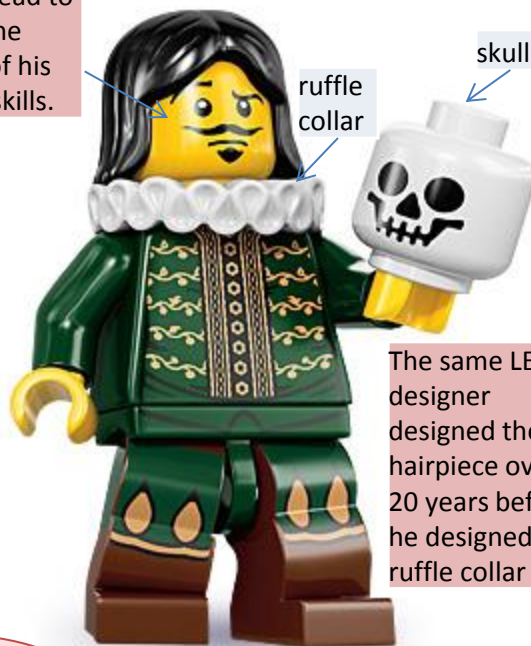

The same LEGO designer designed the hairpiece over 20 years before he designed his ruffle collar

Inspired by Shakespeare.

The Thespian is a master actor, able to slip into any role you can imagine. He plays every part to perfection, from Romeo to Juliet (the lead actress was ill, and the show must go on, after all...), and receives a rousing standing ovation after each and every performance. He’s really good at celebrity impersonations, too.

The Thespian started his career as a minor background player on the old LEGO Studios set, but since those days his fame has really taken off. He constantly gets offers to appear in big-budget movies and television shows, but he always declares that heart will forever belong to the stage. Of course, as much as he enjoys acting, he does occasionally confess that what he’d really like to do is direct!

Bio mentions the Studios Theme. Also called “Actor” in official LEGO material.

- The Actor’s prop skull was used as a snack bowl at the “Brick of Dawn” music video wrap party.



# Pirate Captain

“Yarr! Don’t ye know who I be? And if not, do ye have any suggestions?”

BL Code	# in box	Value	# of parts	# of extras	Face sides	Gender	# of sales	Strength	Creativity	Speed
col08-15	5	\$3.06	7	0	1	M	428	3	2	3



A real pirate is a merciless, rotten son of a sea dog, and that’s exactly what the Pirate Captain aspires to be. He certainly looks the part with his rugged eye-patch, hook-hand and peg-leg, but he has to admit that he’s had a few hiccups along the way.

First of all, his ships keep sinking. No matter whether it’s a man o’ war or a dinghy, any vessel capsizes within five minutes of him coming aboard. Also, he gets seasick really easily – sometimes just a picture of the ocean is enough to set him off. Worst of all, he’s having real trouble coming up with a piracy name. All the good ones – from Ironhook to Brickbeard – seem to already be taken. If he can just come up with a name to strike fear into the hearts of landlubbers everywhere, the Pirate Captain figures the rest of his problems will solve themselves!

Bio mentions 2 previous Pirate theme captains (Ironhook and Brickbeard).

- After a tough day of failed plundering and pirateering, the Pirate Captain likes to relax with a cup of hot chocolate. Chocolate makes everything better.



# Alien Villainess

Rare

“Go forth, my minions, and bring me the universe!”

BL Code	# in box	Value	# of parts	# of extras	Face sides	Gender	# of sales	Strength	Creativity	Speed
col08-16	3	\$4.01	10	0	1	F	281	4	4	4

The only LEGO alien with a pink brain



With a name far too regal (not to mention too long and too unpronounceable) to mention here, the Alien Villainess rules over a vast interstellar empire devoted to one thing and one thing only – total universal conquest! From her towering citadel on the Imperial Throneworld, she sends out fleets of flying saucers to every corner of the galaxy, ordering the commander of each to invade and conquer any planet they find.

From the top of her pulsating purple brain to the tips of her tentacles, the Alien Villainess craves nothing less than absolute control over all of outer space. That’s why it’s so annoying when people try to stop her, especially that pesky **Intergalactic Girl** who keeps arriving at the last minute, escaping her brilliantly inescapable traps and messing up her plans. Don’t they realize that the universe would be so much better if only everybody would swear eternal allegiance to her?

- The Alien Villainess secretly dreams of launching a successful intergalactic clothes line.

# Series 9 – January 2013

Avg price ea	Avg # of parts (not incl extras)	F count	M count	N count	# Sold last 6 mos	MVP Price Name	MVP Price
\$ 3.77	6.625	5	10	1	10317	Forest Maiden	\$5.97

LVP Price Name	LVP price	MVP Qty Name	MVP Qty	LVP Qty Name	LVP qty	Avg Set Price	Avg Case Price
Alien Avenger	\$ 2.80	Heroic Knight	1164	Roller Derby Girl	301	\$ 60.32	\$211.92

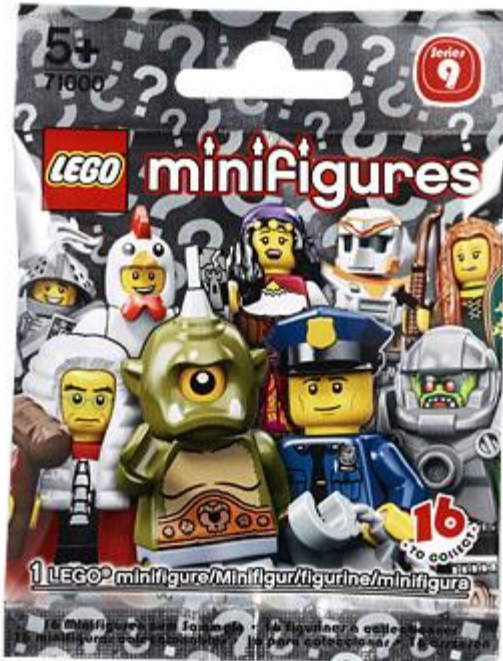

# Series 9 Stats

## Genders

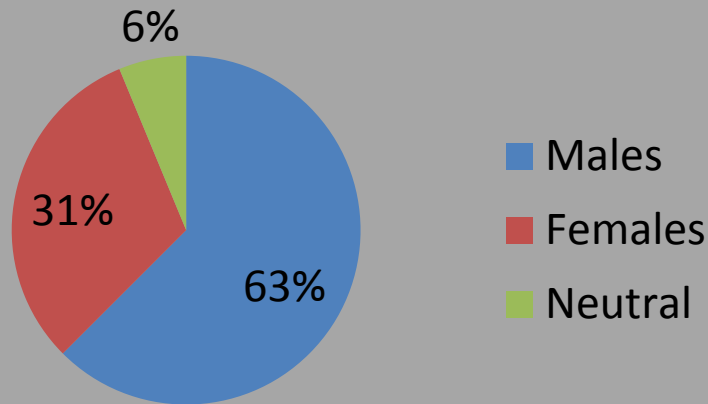

## Value

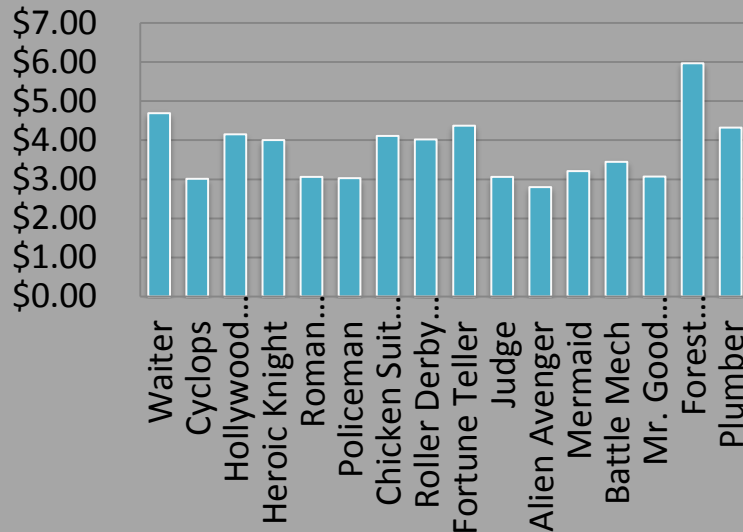

- Most Valuable = Forest Maiden
- Most Popular = Heroic Knight
- Least Valuable = Roller Derby Girl
- Least Popular = Alien Avenger
- Average Set Value = \$60.32
- Average Figure Value = \$3.77
- Average # of Pieces = 6.625
- Rarest figures:
  - Waiter
  - Hollywood Starlet
  - Roller Derby Girl
  - Fortune Teller
  - Forest Maiden
  - Plumber

# Waiter

Very  
Rare

“Good evening. May I recommend this fine green plastic bottle with a picture of grapes on it?”

BL Code	# in box	Value	# of parts	# of extras	Face sides	Gender	# of sales	Strength	Creativity	Speed
col09-1	2	\$4.69	7	0	1	M	386	2	4	3

Bottle was originally labeled “Chateau Pretesacque” in honor of Raphael Pretesacque (LEGO designer) but there wasn’t enough space to print it on the label.



The Waiter is the very model of balance, manners and poise. Perpetually patient and polite, he always knows exactly what drink to serve with each turkey leg, sausage link, or pizza pie his customers order...although it might be because he only has one bottle, and he serves it every time.

There’s just a single thing that rattles the calm of the cool and collected Waiter, and that’s unexpected noises. Something as simple as a hiccup across the room is enough to startle him, and a sneeze once almost made him drop his tray. You don’t even want to know what happens when somebody nearby burps!

# Cyclops

“I’ve got my eye on you.”

BL Code	# in box	Value	# of parts	# of extras	Face sides	Gender	# of sales	Strength	Creativity	Speed
col09-2	6	\$3.01	6	0	2	M	732	5	2	4



Forever watchful and alert, the Cyclops is the only inhabitant of a distant, uncharted island. He stares out to sea with his one unblinking eye, roaring at anyone who sails too close to the shore. But although he looks big and mean, he secretly hides a very sensitive soul beneath his scowling exterior.

Who wants to be a monster all the time? There isn't a lot to do when you live all alone on a deserted island, so the Cyclops spends most of his spare time writing poetry and building sculptures out of driftwood and seashells. He hopes to one day find a friend who really understands him – and with whom he can finally see eye-to-eye!



# Hollywood Starlet

Very  
Rare

“Thank you so much! I couldn’t have done it without all of you!”

BL Code	# in box	Value	# of parts	# of extras	Face sides	Gender	# of sales	Strength	Creativity	Speed
col09-3	2	\$4.15	6	0	1	F	397	2	4	2



The Hollywood Starlet may be new on the movie scene, but she’s on the fast track to becoming the most famous and beloved actress in the world. Beautiful and talented, she can make the audience laugh or reduce them to tears, and keeps them coming back to watch her next performance.

More than anything else, the Hollywood Starlet wants to work with **The Thespian** to create the best movie ever made. She’s tried everything, but so far he’s refused to step in front of the camera. Maybe now that she’s won the top film award, he’ll finally change his mind...and in the meantime, she’ll be acting her heart out on the silver screen!



# Heroic Knight

MVP  
Qty

“It’s all in a day’s work for this good knight!”

BL Code	# in box	Value	# of parts	# of extras	Face sides	Gender	# of sales	Strength	Creativity	Speed
col09-4	6	\$4.00	10	0	1	M	1164	5	3	3

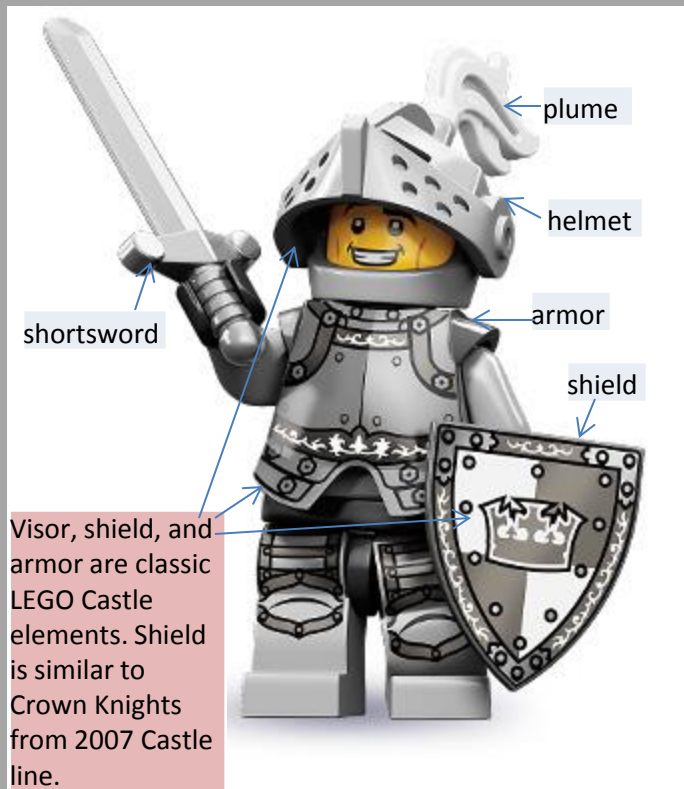

Clad in shining armor and with his sword and shield always at his side, the Heroic Knight is the greatest hero of his age. He rides across the land, fighting for justice and righting wrongs wherever he finds them, and asks for nothing in return except the happiness of those he has helped.

With so many good deeds to perform, even a Heroic Knight can get confused sometimes. He means well, but occasionally he does try to rescue dragons from princesses. Fortunately, the dragons are usually grateful enough to give the kingdom back its stolen treasure!

# Roman Emperor

“I came, I built, I conquered.”

BL Code	# in box	Value	# of parts	# of extras	Face sides	Gender	# of sales	Strength	Creativity	Speed
col09-5	4	\$3.06	6	0	1	M	595	4	3	3

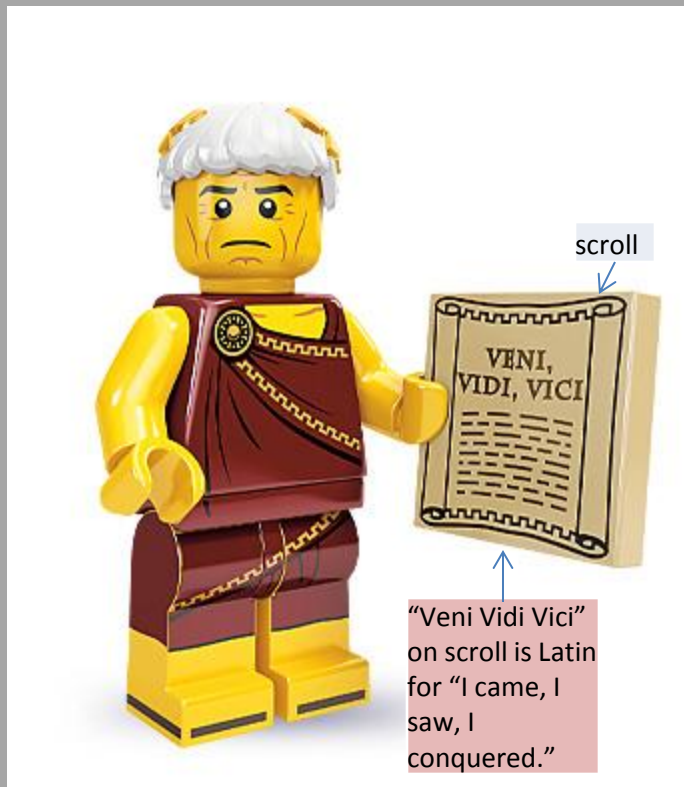

As the ruler of a great ancient empire, the Roman Emperor is used to getting his way all the time. He expects the other Minifigures to polish his sandals, feed him grapes, and carry him around wherever he wants to go, and it really steams him up when anybody disobeys.

There's only one thing that the Roman Emperor likes better than being obeyed, and that's making up new rules for everybody else to follow. He's especially fond of creating extra months in the year and naming them after his favorite food and pets. And if anybody doesn't like celebrating the 5th of Hamstertober, well...that's why he keeps the **Roman Soldier** around!

# Policeman

“Gotcha!”

BL Code	# in box	Value	# of parts	# of extras	Face sides	Gender	# of sales	Strength	Creativity	Speed
col09-6	6	\$3.03	7	0	1	M	887	5	3	4

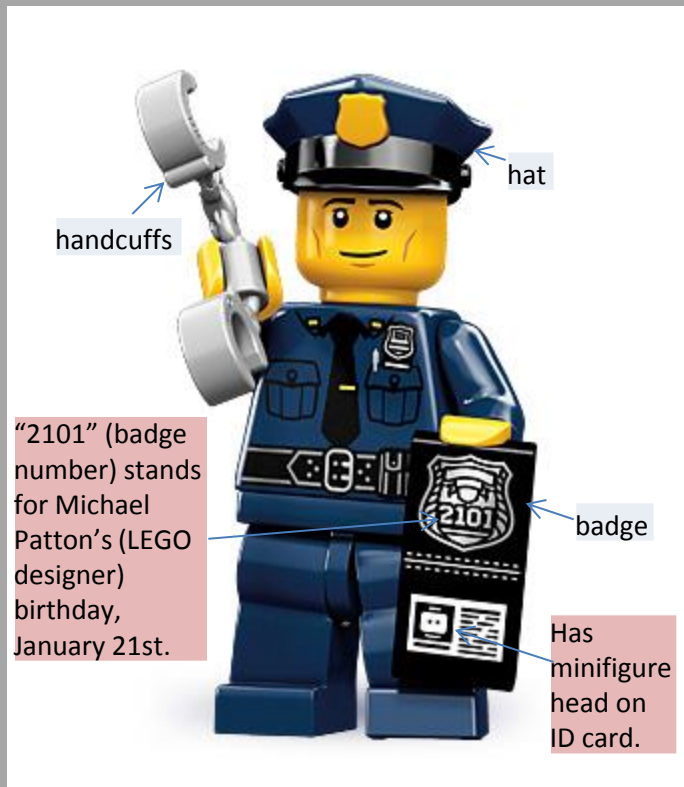

There’s no one more dedicated to catching bad guys than the brave Policeman. He may work out of the big city, but he’ll tirelessly pursue crooks no matter where they try to hide, risking life and limb every day while doing his duty to protect the public and uphold the law.

Robbers may flee to the distant desert or the dense forest, but they’ll always hear the footsteps of the Policeman following behind them. And just when they think they’ve gotten away with the loot, there he’ll be with his shiny badge and handcuffs to arrest them and haul them off to jail. Break the law and beware: the Policeman always gets his Minifigure!

# Chicken Suit Guy

“What you folks need is a guy in a chicken costume!”

BL Code	# in box	Value	# of parts	# of extras	Face sides	Gender	# of sales	Strength	Creativity	Speed
col09-7	4	\$4.11	5	0	1	M	876	2	5	3



The Chicken Suit Guy started out as a fast-food mascot, but he knew that he could be much more. If he could help people decide what to have for lunch, then surely there must be other ways that he could help too. So he set out on the road and started to travel the world in search of adventure.

Now wherever people are in trouble, the Chicken Suit Guy will be there, flapping his wings and making clucking sounds until the crisis is over. It's hard to say how he always ends up going exactly where he's needed most, but everyone is glad to know that there's a Minifigure in a giant chicken costume looking out for them!

# Roller Derby Girl

Very  
Rare

“Can’t stop now – I’m on a roll!”

BL Code	# in box	Value	# of parts	# of extras	Face sides	Gender	# of sales	Strength	Creativity	Speed
col09-8	2	\$4.02	7	0	1	F	301	3	4	5



When the Roller Derby Girl starts speeding along on her skates, nothing slows her down – and nothing had better get in her way! She’ll zoom right through any obstacle, large or small, leaving rival players spinning dizzily in her wake. It’s a skill that has made her one of the best roller derby scorers around. The only downside? Once she really gets going, she just can’t stop herself!

When the game is done, she skates right through the door and through the city, rolling faster and faster as she goes. Soon she’s a red and blue blur, leaving scorch marks on the road in her wake. By the time the Roller Derby Girl finally manages to slow down, she might be in another town or another country. Once she even found herself on a whole different continent!

# Fortune Teller

Very  
Rare

“You will lead a long and uneventful life. Or maybe you’ll be kidnapped by aliens!”

BL Code	# in box	Value	# of parts	# of extras	Face sides	Gender	# of sales	Strength	Creativity	Speed
col09-9	2	\$4.37	7	0	1	F	345	2	5	2



The mystical Fortune Teller has a unique gift for prophecy...sometimes. Half of her predictions come true in every last detail, while the other half turn out to be wildly wrong. Even she doesn't know which ones are which. It's led to some very happy customers – and some extremely annoyed ones, too.

It's gotten to be such a big problem that the Fortune Teller has started second-guessing her own second sight. Whenever she tells someone's fortune, she also makes something up that's the exact opposite. It may be confusing, but at least she can be reasonably certain that she'll always be at least half-right!



# Judge

“I’ll be the judge of that!”

BL Code	# in box	Value	# of parts	# of extras	Face sides	Gender	# of sales	Strength	Creativity	Speed
col09-10	4	\$3.06	7	0	1	M	619	3	3	3

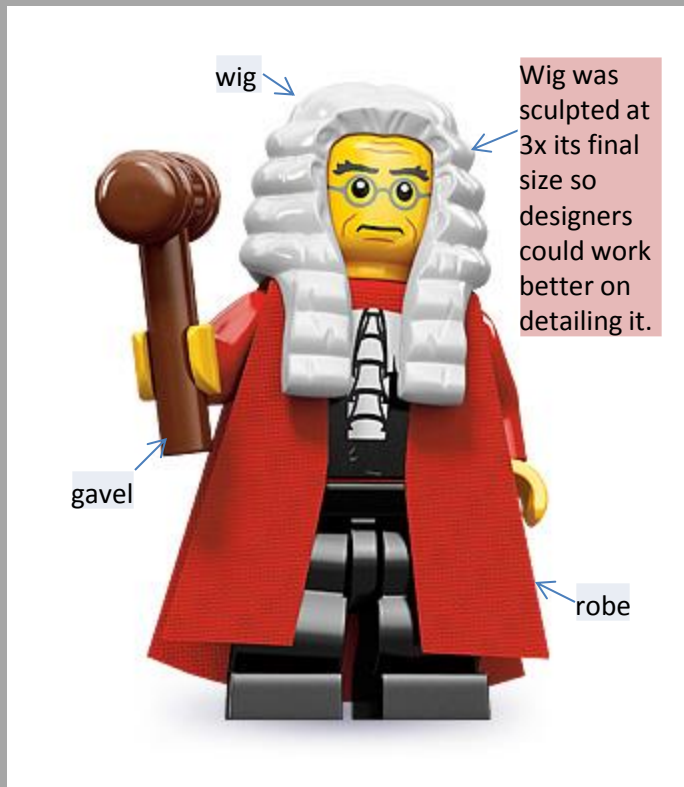

The stern Judge considers himself to have the final word on everything. When court is in session, he’s a force of justice, settling arguments and separating the innocent from the guilty with wisdom, a vast knowledge of the law, and his mighty wooden gavel.

Outside the court, though, he keeps on judging everything he sees. He judges how well flowers are arranged in gardens, how tasty the condiments are on his burger, and how talented people are as musicians if they happen to whistle as they walk down the street. With each weighty judgment he makes, the Judge bangs his gavel to declare that the matter has been decided once and for all!

# Alien Avenger

“Smash, mash, and destroy!”

BL Code	# in box	Value	# of parts	# of extras	Face sides	Gender	# of sales	Strength	Creativity	Speed
col09-11	6	\$2.80	7	0	1	M	1138	5	3	4

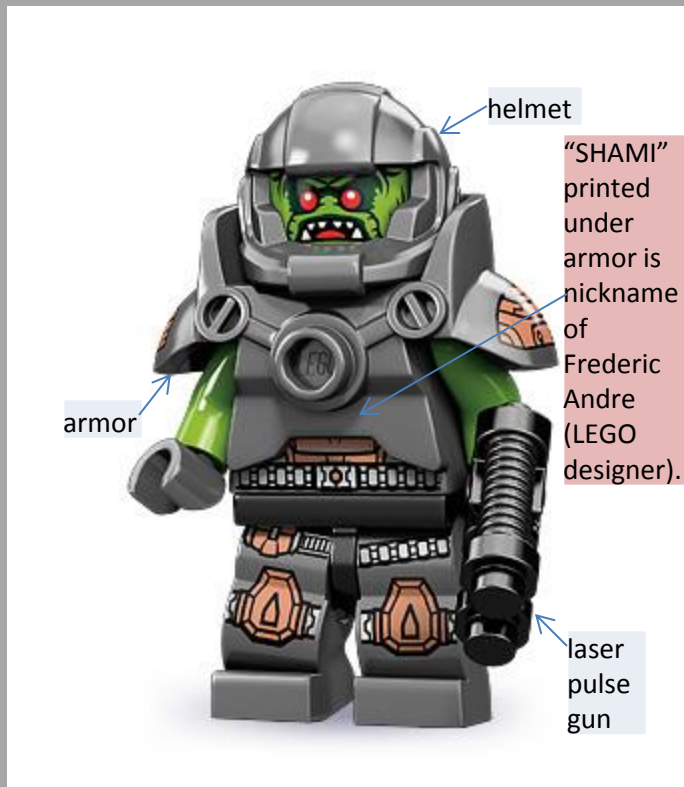

The Alien Avenger is part of a team of rough, tough space warriors assembled from all across the galaxy. With armor and weapons scavenged from the battlefields of a hundred war-torn worlds, he may lack military discipline, but he makes up for it with brute strength and eagerness to charge into battle no matter the odds.

As one of 5,000 identical siblings, the Alien Avenger is used to not standing out in a crowd. But it doesn't bother him that some may see him as just another nameless, faceless trooper – give him a planetoid beneath his feet and a disintegrator blaster in his hand, and he'll take on anything and everything that comes his way!

# Mermaid

“I wonder if I should have turned at Easter Island...”

BL Code	# in box	Value	# of parts	# of extras	Face sides	Gender	# of sales	Strength	Creativity	Speed
col09-12	4	\$3.21	6	0	1	F	699	2	5	3



Most mermaids spend their time frolicking beneath the waves, but this one has a special calling: she's determined to become the first mer-person to ever swim all the way around the world. With the **Ocean King's** blessing and her lucky starfish for company, she's set out to circumnavigate the globe by sea and to see all of the exciting sights along the way. So far, she's seen bridges and boats, lighthouses and lagoons. She's gone swimming with penguins, tide-raced with sea turtles, and once even went on a people-spotting tour with a group of friendly whales. The only thing the Mermaid regrets about her trip is that she hasn't been able to find an underwater mailbox to send all of her postcards home!

# Battle Mech

“To the rescue – go!”

BL Code	# in box	Value	# of parts	# of extras	Face sides	Gender	# of sales	Strength	Creativity	Speed
col09-13	4	\$3.45	6	0	1	N	703	5	3	5



Whenever danger threatens the planet, the mighty Battle Mech goes into action! Launching from its secret base, it blasts through the sky on powerful retro-rockets, using an arsenal of built-in weaponry and gadgets to battle enormous space monsters, out-of-control asteroids, and other perils.

No one knows for sure who built the Battle Mech or who commands it on its missions. Did it come from another dimension where it stood thirty stories tall? Is it remote-controlled by a team of young science students? Whatever the truth, there's no denying that it's one of the greatest hi-tech defenders the world has ever known!

Designed in Japanese comic style.

# Mr. Good and Evil

“Should I build or deconstruct today?”

BL Code	# in box	Value	# of parts	# of extras	Face sides	Gender	# of sales	Strength	Creativity	Speed
col09-14	4	\$3.07	6	0	1	M	713	3	5	3



Transformed by a laboratory accident, Mr. Good and Evil has been split into a good side and a bad side. Half of him wants to help people and solve problems, while the other half craves nothing but chaos and destruction.

Because both halves are in the same body, they're constantly trying to sabotage each other. As a result, everything good that he tries to do ends up at least a little bit bad, and everything bad comes out a little bit good. According to the other Minifigures, it actually makes him a pretty decent neighbor...if you don't mind all of the arguing!

Fan  
Favorite

# Forest Maiden

MVP  
Price

Very  
Rare

“You can seek, but you won’t find me!”

BL Code	# in box	Value	# of parts	# of extras	Face sides	Gender	# of sales	Strength	Creativity	Speed
col09-15	2	\$5.97	7	0	1	F	436	2	4	2



The spirited Forest Maiden often played in the deep woods as a child, and now that she’s grown up, she knows each root and branch by heart. As a member of the **Forestman’s** merry band, she can slip silently into the trees and shadows to disappear from sight...but her greatest skill lies in building traps.

From rope snares hidden in the grass to wooden cages that drop down from above, the Forest Maiden knows the best way to capture any creature that might invade her woods or threaten her home and friends. And if an enemy should happen to avoid her traps, then watch out – her bow and shield aren’t just for decoration!



# Plumber

Very  
Rare

“Looks like another tough job for ol’ Plungey!”

BL Code	# in box	Value	# of parts	# of extras	Face sides	Gender	# of sales	Strength	Creativity	Speed
col09-16	2	\$4.32	6	0	1	M	326	3	1	3



Few Minifigures work harder than the good-natured Plumber. He'll tackle any job, no matter how messy it may be, and always goes to work with a cheery smile on his face. As long as he's got his trusty plunger and his can-do attitude, there's nothing he can't handle.

It's a good thing he's willing to take on tough projects, because you wouldn't believe the strange things the Plumber encounters on an average day. From lost civilizations in the sewers to alien invaders in the plumbing, he's seen it all...and even more impressively, he always gets the toilet unclogged in the end!



# Series 10 Stats

(Stats on Series 10 do not include Mr. Gold)

## Genders

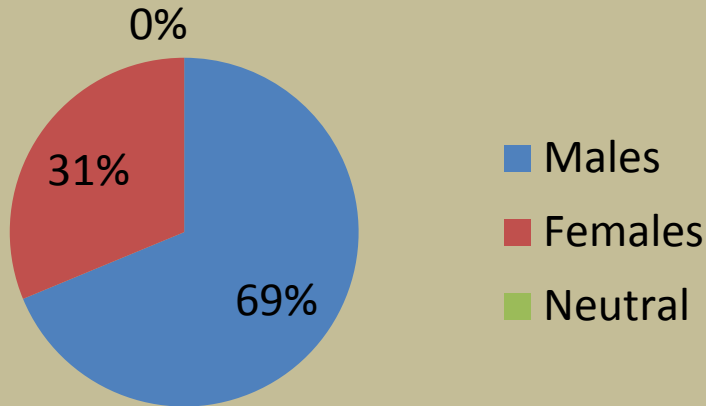

## Value

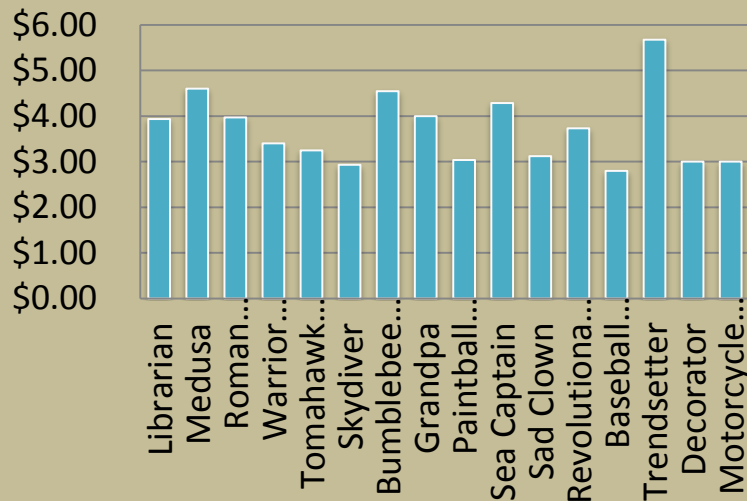

- Most Valuable = Trendsetter
- Most Popular = Roman Commander
- Least Valuable = Baseball Fielder
- Least Popular = Decorator
- Average Set Value = \$59.30
- Average Figure Value = \$3.71
- Average # of Pieces = 6.625
- Rarest figures:
  - Librarian
  - Medusa
  - Bumblebee Girl
  - Grandpa
  - Sea Captain
  - Trendsetter

# Librarian

“Shhh!”

Very  
Rare

BL Code	# in box	Value	# of parts	# of extras	Face sides	Gender	# of sales	Strength	Creativity	Speed
col10-1	2	\$3.94	7	0	1	F	1214	3	4	2



Books are just about the Librarian’s most favorite thing in the entire world. Reading them can take you on exciting adventures in far-off lands, introduce you to new friends and cultures, and let you discover poetry, classic literature, science fiction and much more. If only everybody loved to read as much as she does, the world would be a better place...and quieter, too!

The Librarian feels that it’s extremely important to treat a book with the proper respect. You should always use a bookmark instead of folding down the corner of the page. Take good care of the dust jacket, and don’t scribble in the margins. And above all else, never – ever – return it to the library late!

- The Librarian’s second favorite thing in the world is reading to children. She runs her own audio book recording studio where kids can record their own favorite books. Best of both worlds!

# Medusa

Very  
Rare

“Look thisssss way, my dear.”

BL Code	# in box	Value	# of parts	# of extras	Face sides	Gender	# of sales	Strength	Creativity	Speed
col10-2	2	\$4.60	5	0	2	F	1460	4	3	4



As a mythical Gorgon, Medusa has the power to instantly turn any creature that looks directly at her to solid stone. Some people might think of this as a curse, but she loves it, even if the effect does only last a few hours.

Unfortunately for her mischievous hobby, her legend has become so well-known that almost nobody falls into Medusa's trap these days. She's tried all kinds of tricks, like hiding behind bushes and suddenly jumping out, pretending to be inside a TV set, and going undercover in the reptile house at the zoo...but the hissing of her hair always gives her away!

- Since the scaring people to stone business has started going south in a speedy fashion, Medusa is now working on a line of exclusive hair care/reptile food products.



# Roman Commander

“For the glory of Rome!”

BL Code	# in box	Value	# of parts	# of extras	Face sides	Gender	# of sales	Strength	Creativity	Speed
col10-3	6	\$3.97	8	0	1	M	3610	5	3	5

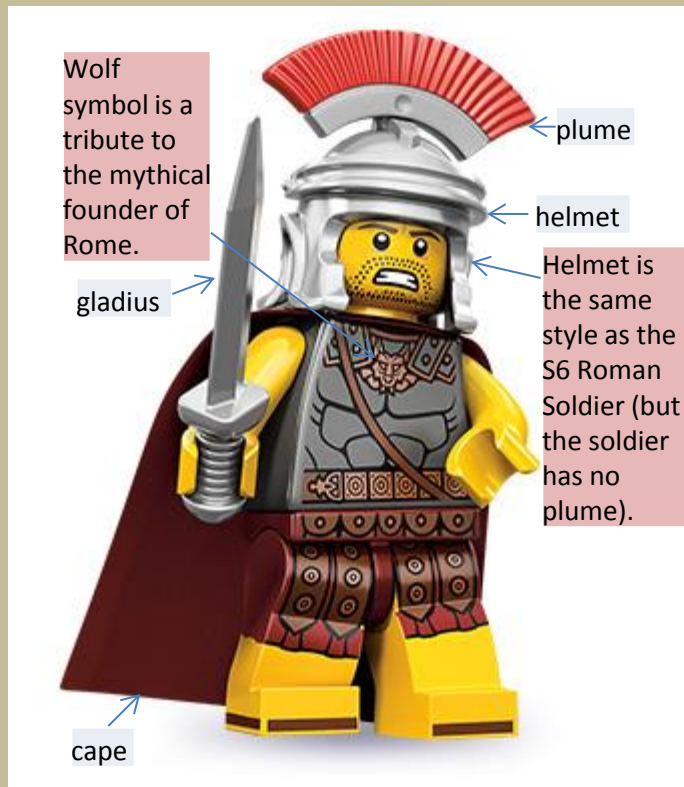

The Roman Commander can't wait to lead the legions of Rome to victory. He keeps his sword sharpened, his armor polished, and his helmet's horsehair crest neatly brushed at all times, just waiting for his emperor to give the order to charge.

The Roman Commander has studied all of the great battles and is sure that his tactics will win the day. The empire's enemies will surrender, its borders will grow, and he will join the ranks of the most famous military leaders in history. He's sometimes a little worried about the fact that his legions are made up of a single **Roman Soldier**, but at least it makes it easy to shout out commands!

- The plume on the Roman Soldier's helmet was made from plant-dyed straw. Usually these plumes are made from horse hair, but he has no horse. Or hair.



# Warrior Woman

“Surrender or taste defeat!”

BL Code	# in box	Value	# of parts	# of extras	Face sides	Gender	# of sales	Strength	Creativity	Speed
col10-4	4	\$3.40	7	0	1	F	1333	5	3	4

Inspired by barbarian-fantasy books and movies.



A fierce fighter from a long-forgotten age, the Warrior Woman has earned her reputation in pitched battle with pirates, brigands and beasts all across the land. She doesn't have the most civilized of manners, but her savage skill with spear and shield ensures that no one ever complains to her face.

Although even her closest friends don't know the truth, the Warrior Woman was originally raised as a pampered princess in a distant kingdom. She eventually got tired of the royal life and ran off to be a mighty warrior instead – and she's never regretted it for a single moment since!

- The Warrior Woman has a pet dragon named Ralph. She freed it from its shackles in the castle dungeons before she ran away from home.

# Tomahawk Warrior

“Here’s another trick I can do with my tomahawk!”

BL Code	# in box	Value	# of parts	# of extras	Face sides	Gender	# of sales	Strength	Creativity	Speed
col10-5	4	\$3.25	6	0	1	M	1258	5	4	4



The Tomahawk Warrior uses his tomahawk for just about everything. He made it himself as a youngster, and it hasn't left his side ever since. Over the years, he's become an expert at finding all sorts of handy new things that it can do.

It can help build a boat, and it can open his mail. It can slice a pizza, cut firewood, or make a shelter when it's cold and rainy. It can even be used to carve the handles for more tomahawks. The Tomahawk Warrior doesn't know what he'd do if he lost his beloved tomahawk, and he doesn't intend to ever find out!

- The Tomahawk Warrior's many tomahawks are becoming a bit of a space issue. He's currently looking into starting an online shop so he can sell some of them.

# Skydiver

“I’ll be jumping any second now. Yup, any second now.”

BL Code	# in box	Value	# of parts	# of extras	Face sides	Gender	# of sales	Strength	Creativity	Speed
col10-6	6	\$2.93	6	0	1	M	1285	4	4	4



The Skydiver has been training for a long time, and today he’s finally going to make his first big jump. The plane is in position, the door is open, and now all he’s got to do is hop out into the open air!

Maybe he’d better check his gear first. His helmet is in place...all of his straps and buckles are secure...but what about his parachute?! Phew, looks like it’s still right there on his back. Okay, everything’s set. Time to go!

3...2...1...or then again, maybe the Skydiver should check his gear one more time just to be on the safe side!

- The thing people fear the most when it really comes down to it, is fear itself. Not for the poor Skydiver. He fears falling out of a small plane and landing head first in a volcano more than anything.

# Bumblebee Girl

Very  
Rare

“Buzz buzz buzz!”

BL Code	# in box	Value	# of parts	# of extras	Face sides	Gender	# of sales	Strength	Creativity	Speed
col10-7	2	\$4.55	7	0	1	F	1544	4	3	5

First female costumed minifigure.



The Bumblebee Girl loves honey so much that she decided to become a fuzzy bumblebee herself. Sewing a homemade costume, she patiently waited near a hive until the bees accepted her as one of their own, and then joined them in buzzing around the meadow gathering nectar and pollen.

The happy and fun-loving Bumblebee Girl has become a familiar sight as she buzzes through town looking for flowers with her friends from the hive. She did eventually find out that bumblebees don't make very much honey...but she's having so much fun being a bee that she doesn't really mind!

- Bumblebee Girl was offered a job as a tour guide at the botanical gardens. She turned it down when they wouldn't let her sleep in the flower beds.

# Grandpa

Very  
Rare

“Everything was better back in my day!”

BL Code	# in box	Value	# of parts	# of extras	Face sides	Gender	# of sales	Strength	Creativity	Speed
col10-8	2	\$4.00	7	0	1	M	1014	2	3	1



Grandpa preferred everything the way it was when he was young, and he'll tell you so every chance he gets. Mention that you liked the old brown LEGO® bricks better than the new ones, and he'll say that when he was a kid, the only color you could get was red and you were happy to have it.

Ever since the first play themes came around, he's been grumpy about all of those new-fangled pieces like doors, windows, and anything else that isn't shaped like a brick. And don't even get him started on today's Minifigures with their fancy arms and legs and facial expressions!

- Grandpa's grandchildren keep telling him to give his ancient vinyl records and gramophone to the National Museum of History. “Young people just don't understand.”

# Paintball Player

“Ah, the most dangerous game...paintball!”

BL Code	# in box	Value	# of parts	# of extras	Face sides	Gender	# of sales	Strength	Creativity	Speed
col10-9	4	\$3.04	7	0	1	M	1131	4	4	4



The Paintball Player is constantly challenging his friends to paintball matches. When he plays, it's with plenty of enthusiasm...maybe too much, because his excited whooping and hollering always seem to result in him getting totally splattered with paint as soon as the match begins.

But the Paintball Player doesn't mind. As far as he's concerned, he's the best player in the most exciting sport around, and no amount of losses – or paint all over his clothes and helmet – will ever change his mind. And if his teammates object...well, they're probably just not playing the game right!

- Paintball is a dangerous sport. The Paintball player still suffers from the hip injury he suffered when he tripped over his suit in the changing room.



# Sea Captain

Very  
Rare

“Another Kraken? Let me know if you spot one with ten heads.”

BL Code	# in box	Value	# of parts	# of extras	Face sides	Gender	# of sales	Strength	Creativity	Speed
col10-10	2	\$4.29	7	0	1	M	1187	4	4	3

Inspired by Ivar Haglund, founder of Ivar's Restaurant in Seattle, Washington.



The grizzled Sea Captain has been a nautical man his whole life, and it's left him kind of jaded. Although he loves ocean adventure, these days it seems like nothing is quite exciting enough. When you've been to as many exotic places and seen as many unexpected sights as he has, you start to get used to it all.

Experiences that would amaze and thrill a younger sailor – like roaring whirlpools, thundering typhoons, and giant octopus attacks – just make the Sea Captain shrug and double-check his ship's course. The rest of his crew wonders what it would take to impress their Cap'n...and they're a little afraid of discovering the answer some day!

- They say sea captains often use words you shouldn't repeat in the company of children. Our sea captain really tries to speak nicely, but if you hear kids using words they shouldn't, maybe they've learned them from him.

# Sad Clown

“Why laugh when you can cry?”

BL Code	# in box	Value	# of parts	# of extras	Face sides	Gender	# of sales	Strength	Creativity	Speed
col10-11	4	\$3.12	6	0	1	M	1285	4	5	3

Inspired by Pierrot, a 17<sup>th</sup> Century pantomime character.

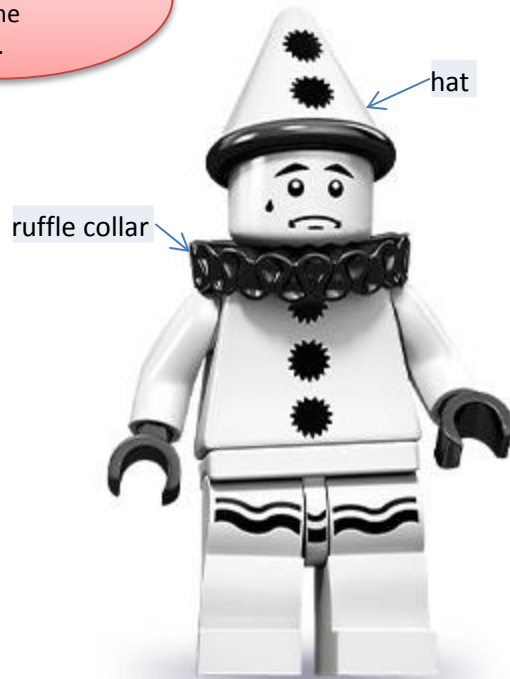

To the Sad Clown, everything in life is a tragedy. Things that other Minifigures find joyful and jolly only fill him with sadness and woe. Not even puppies, kittens and birthday parties can turn his melancholy frown upside-down.

Many have tried to cheer him up with surprise presents, funny internet videos, and their favorite knock-knock jokes. But no matter what they do or say, he just sits there and sighs. If only they understood that the Sad Clown is only truly happy when he's totally and completely miserable!

- The Sad Clown has catalogued, rehearsed and perfected 173 different ways to sigh. And that's just when he's sitting down.

# Revolutionary Soldier

“Give me liberty or give me disassembly!”

BL Code	# in box	Value	# of parts	# of extras	Face sides	Gender	# of sales	Strength	Creativity	Speed
col10-12	4	\$3.73	6	0	1	M	2138	4	4	4

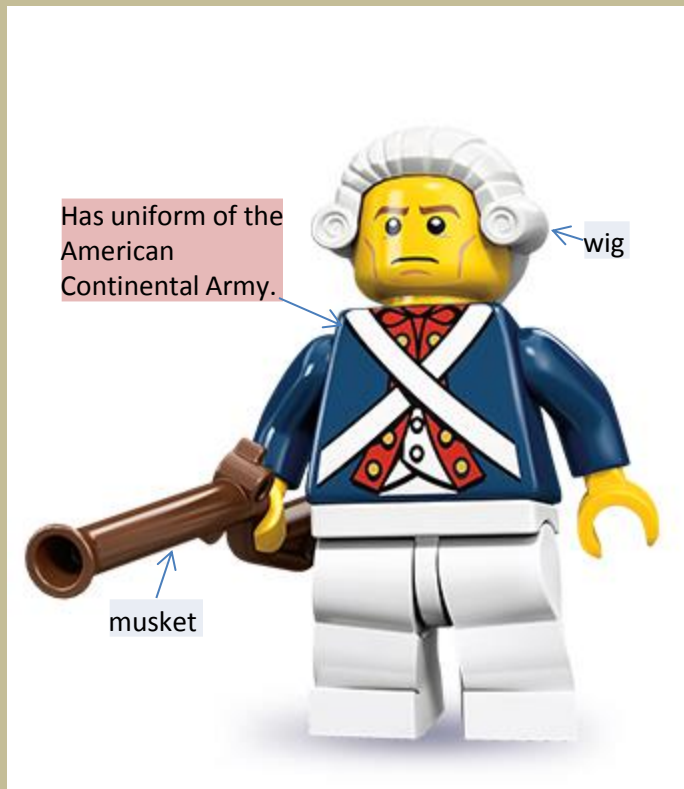

Nothing is more important to the Revolutionary Soldier than freedom. His greatest wish is to see all people be free of hardship and oppression, and he'll do everything he can to help make it a reality.

The Revolutionary Soldier doesn't like fighting, but if that's what it will take to protect his fellow Minifigures, then that's what he'll have to do. With his musket in his hand and his best powdered wig on his head, he's here to stand up for independence and the rights of the little guy!

Quote is a play on Patrick Henry's famous speech.

- Once, in the heat of battle, an enemy grabbed the Revolutionary Soldier's wig and held it hostage for a pack of licorice allsorts. They settled for caramels because licorice allsorts weren't invented yet.

# Baseball Fielder

“I got it! I got it!”

BL Code	# in box	Value	# of parts	# of extras	Face sides	Gender	# of sales	Strength	Creativity	Speed
col10-13	6	\$2.80	5	0	1	M	1606	4	4	5



With the help of his lucky mitt, the Baseball Fielder can catch just about anything. From line drives to pop flies, if it’s in the air and heading his way, you can trust that it will end up safely in his big leather glove.

And baseballs aren’t the only thing that the Baseball Fielder catches. From his position in the outfield, he’s caught souvenirs dropped by fans, runaway rockets, and a falling star or two. He once even caught a bad cold, but then he had to sit out of the game for half a season!

- The Baseball Fielder is going for the world record for most games played. He already holds the world record for strangest object ever caught in a major league baseball game: a **skydiver**.

# Trendsetter

MVP  
Price

Very  
Rare

“It’s not easy to be super fashionable and popular all the time!”

BL Code	# in box	Value	# of parts	# of extras	Face sides	Gender	# of sales	Strength	Creativity	Speed
col10-14	2	\$5.68	7	0	1	F	1081	2	5	3

“LOL” and “BFF” on phone are abbreviations for “Laugh Out Loud” and “Best Friends Forever.”

mobile phone

chihuahua



Everything the Trendsetter does becomes the next big thing. If she buys a certain phone, so does everybody else. If she reads a particular magazine, everyone else reads it too. All of the Minifigures that she meets want to look like her, act like her, and do all of the same things she likes to do.

The Trendsetter has to really think about the trends she’s going to set. If everybody buys her favorite food and clothes, then there won’t be any left for her, and if people know what movie she’s planning to see, the theater might sell out before she gets there. She isn’t sure why everybody seems to want to be just like her...but she has to admit that she doesn’t mind the attention one bit!

- The Trendsetter’s upcoming fad projects include crocheted suits and ties, gourmet cooking with broccoli and celery, and purses and school bags made from LEGO® bricks.

# Decorator

“Is this the right purple? It looks a little off...”

BL Code	# in box	Value	# of parts	# of extras	Face sides	Gender	# of sales	Strength	Creativity	Speed
col10-15	4	\$3.00	9	0	1	M	917	4	5	4

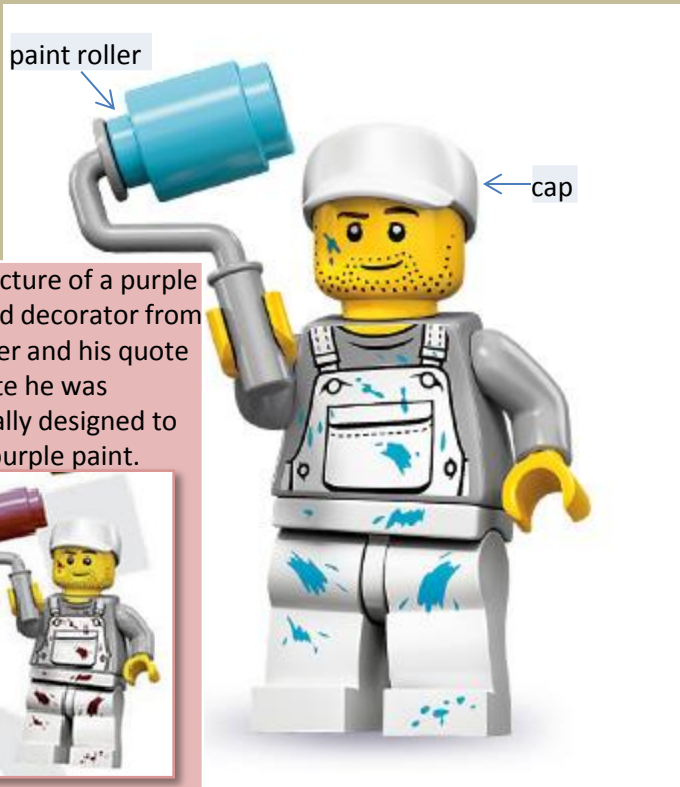

This Decorator does more than just paint houses. He’s also responsible for coloring each and every LEGO® brick! You didn’t think that they just popped out of a big machine that way, did you?

With the help of his handy roller, the Decorator adds shade and tint to elements as they come down the production line. He paints them on all sides, making sure to coat each stud on top and tube underneath, and he takes care to get any special details just right. So the next time you reach into a big box of bricks, remember who to thank for making them look so bright and colorful!

- The Decorator’s biggest dream is to paint the worlds’ mountains and deserts in every color of the rainbow, so when people in airplanes look out the windows, they’ll have something beautiful to look at.



# Motorcycle Mechanic

“Clunking sound? Yeah, that’s supposed to be there.”

BL Code	# in box	Value	# of parts	# of extras	Face sides	Gender	# of sales	Strength	Creativity	Speed
col10-16	6	\$3.00	6	0	1	M	993	5	2	4



When you want your ride to really roar, you take it to the Motorcycle Mechanic. He may look scruffy, but this veteran biker knows every inch of a motorcycle inside and out, and there’s no one else around who’s as good at making them perform their best.

Make no mistake: your bike may not look very pretty by the time the Motorcycle Mechanic gets done with it. His method of fixing up a part involves banging on it with his wrench until it works, and he says that any resulting dents, clanks or rattles just give a cycle more personality. But you’ll have to admit that after one of his repair jobs, it definitely runs faster, further, and above all LOUDER than ever before!

- Motorcycle Mechanic guy is working on a very secret project: the most monstrous motorcycle ever made to drive the open road. When it’s finished, it will include a hot tub, a burger bar and a helipad.

# Mr. Gold

“I dare say it’s your lucky day!”



BL Code	# in box	Value	# of parts	# of extras	Face sides	Gender	# of sales	Strength	Creativity	Speed
col10-17	0	\$617.44	7	0	1	M	27	5	5	5



Rumor has it that somewhere out there is a very special Minifigure known as Mr. Gold. Shining and golden from the top of his tall top hat to the tips of his toes, he may be discovered in all sorts of unexpected places, but he never seems to turn up exactly when and where you’re looking for him. According to legend, Mr. Gold will bring you luck if you happen to spot him...or is it that you’ll need to have a lot of luck to find him? Either way, everybody wants to find the mysterious Golden Minifigure – but only a fortunate few will succeed!

- It is said that Mr. Gold speaks 6,502 languages. (Some of them are not in use anymore. Like Gibberish or Elvish.) So no matter where in the world he pops up, he can talk with people and make new friends.



# Series 11 Stats

## Genders

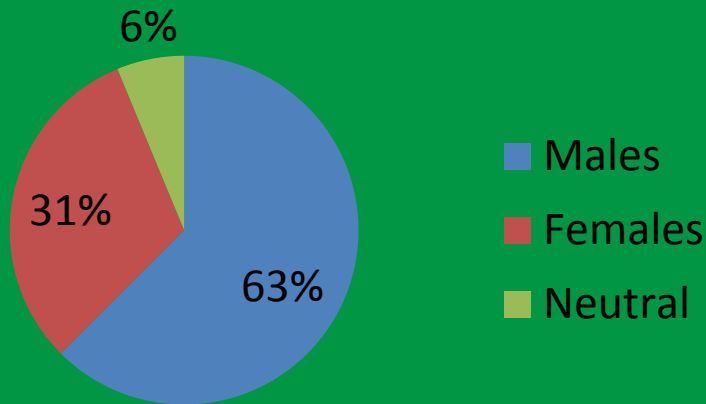

## Value

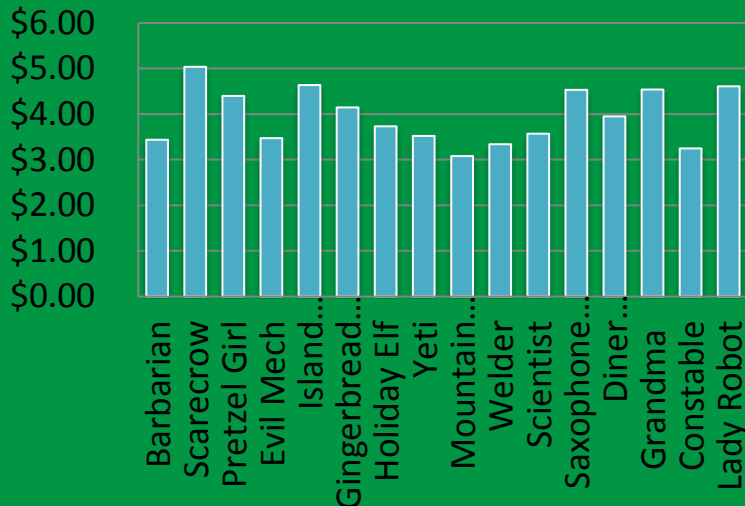

- Most Valuable = Scarecrow
- Most Popular = Gingerbread Man
- Least Valuable = Mountain Climber
- Least Popular = Mountain Climber
- Average Set Value = \$63.26
- Average Figure Value = \$3.95
- Average # of Pieces = 6.9375
- Rarest figures:
  - Scarecrow
  - Pretzel Girl
  - Island Warrior
  - Saxophone Player
  - Diner Waitress
  - Grandma

# Barbarian

“Don’t get in my way!”

BL Code	# in box	Value	# of parts	# of extras	Face sides	Gender	# of sales	Strength	Creativity	Speed
col11-1	4	\$3.44	7	0	1	M	432	5	2	3



There isn't a monster, prison tower, or evil tyrant in the world that the Barbarian wouldn't try to demolish. With powerful muscles from a life in the savage wilderness and a sword gripped in each hand, he smashes, bashes, and crashes his way through every obstacle in his path, no matter how tough or dangerous it may be.

People say that the Barbarian is utterly unstoppable, and they're almost right. He doesn't blink at ogres, trolls, or many-headed hydras, and he laughs in the faces of evil sorcerers and axe-wielding viziers. So what's the one thing that gives this burly brawler pause? He's terrible at spelling. That's why he's started spending his weekends at the library, practicing his reading!



Fan  
Favorite

# Scarecrow

MVP  
Price

Very  
Rare

“Let me know if you see any birds around here!”

BL Code	# in box	Value	# of parts	# of extras	Face sides	Gender	# of sales	Strength	Creativity	Speed
col11-2	2	\$5.04	7	0	1	M	595	1	3	3



The Scarecrow takes his duty of keeping birds out of the farmer's cornfield very seriously, and he tries his hardest to frighten them off whenever he sees one fly near. He thinks he's the spookiest thing around, since no one has ever told him that with his smiling face and button eyes, he actually doesn't look all that scary. Although he can't tell through his straw-stuffed noggin, the Scarecrow's wide-brimmed old hat has become a favorite perch for a local crow. It always politely waits until he's not looking before it swoops down to nab a snack, so as far as he can tell, he's doing a perfect job!



# Pretzel Girl

Very  
Rare

“Who needs a phone when you can yodel?”

BL Code	# in box	Value	# of parts	# of extras	Face sides	Gender	# of sales	Strength	Creativity	Speed
col11-3	2	\$4.40	7	0	1	F	447	3	4	3



Every morning, the Pretzel Girl dresses up in her traditional clothes and climbs up to the hills to practice her yodeling. She has to do it far away from her village, because her very impressive yodel can be heard for miles around and has been known to occasionally cause avalanches.

With the sheer volume and pitch-changes of her yodeling song, the Pretzel Girl shares all of the latest news with her fellow yodelers in distant towns, and they yodel right back with everything that's going on with them. It might be easier to use a phone or e-mail, but somehow it just wouldn't be as much fun!

# Evil Mech

“Kzzt! Mission accomplished.”

BL Code	# in box	Value	# of parts	# of extras	Face sides	Gender	# of sales	Strength	Creativity	Speed
col11-4	4	\$3.47	8	0	1	N	490	5	2	3

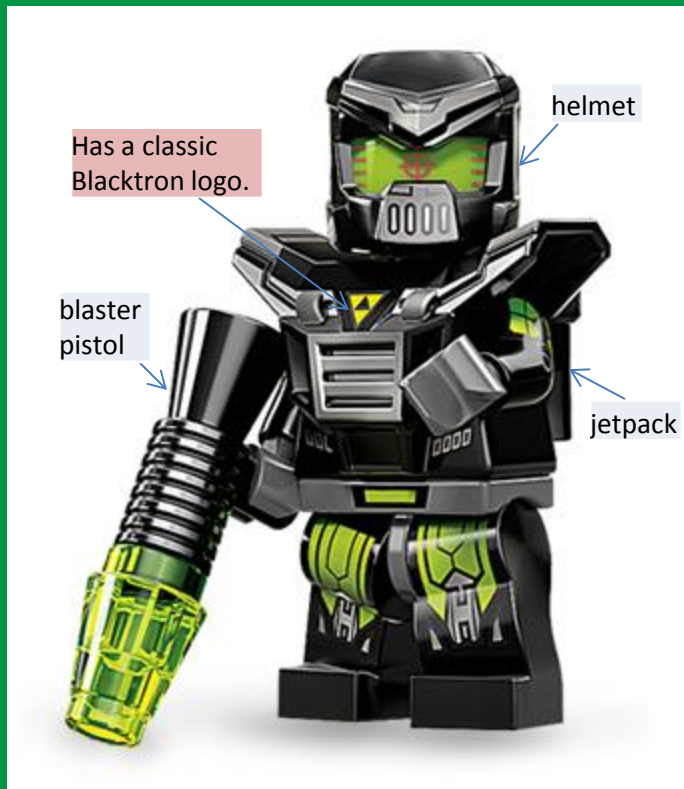

Built with antimatter microcircuits etched in the heart of a black hole and programmed by the top cyber-slicer of the sinister Blacktron space raiders, the Evil Mech is a dangerous force for interplanetary crime and chaos.

A cutting-edge nano-coating lets this robotic menace slip through force fields and scanner nets undetected, allowing it to steal, spy, or sabotage as its mission commands. The good news is that the Evil Mech is one of a kind...but if its design is ever duplicated, it could lead the way to a fearsome future generation that would make the galaxies tremble.

# Island Warrior

Very  
Rare

“Go away now!”

BL Code	# in box	Value	# of parts	# of extras	Face sides	Gender	# of sales	Strength	Creativity	Speed
col11-5	2	\$4.64	8	0	1	M	637	5	4	5



The Island Warrior keeps vigilant watch over the forbidden cove of his enchanted island home. When he spots a ship sailing near, whether it flies the skull-and-crossbones or the flag of the Imperial navy, he puts on his carved wooden mask and gets ready to drive off any un-neighborly visitors.

Fortunately, he's well prepared thanks to his friends. With a knowledge of traps learned from the **Forest Maiden**, lessons in stealth from the **Elf**, and the **Leprechaun's** book full of pranks, the Island Warrior has everything he needs to send any pesky plunderers who try to invade his island packing!

# Gingerbread Man

MVP  
Qty

“Try and catch me!”

BL Code	# in box	Value	# of parts	# of extras	Face sides	Gender	# of sales	Strength	Creativity	Speed
col11-6	4	\$4.15	5	0	1	M	1126	1	4	3



The Gingerbread Man is always trying to get people to chase him. Maybe someone added a little too much sugary molasses to the recipe when he was made, or maybe it's just baked into his gingerbread nature, but he's constantly running around town to show off how he's the fastest thing on two icing-frosted feet.

It must be said that a big, round, flat head isn't the most aerodynamic thing to have sitting on top of your shoulders when you're sprinting at full speed. It's nearly gotten the Gingerbread Man caught a few times. He's tried turning it sideways, but then he can't see where he's going!

# Holiday Elf

“It’s always a holiday somewhere!”

BL Code	# in box	Value	# of parts	# of extras	Face sides	Gender	# of sales	Strength	Creativity	Speed
col11-7	4	\$3.73	8	0	1	M	585	2	5	3



Some elves might spend all of their time getting ready for just one or two special days a year, but that isn’t enough for the festive Holiday Elf. He thinks that every day should be a holiday, and it’s his job to work extra hard in order to make sure that everybody has a good one!

The Holiday Elf knows how to make any kind of toy in the world, whether classic or brand-new. He can wrap a gift so quickly that it seems like magic, and he does it all with a cheerful smile. If you’ve ever gotten a present and you weren’t quite sure why, it was probably this little fellow making sure your every-day holiday was happy and bright!

# Yeti

“Yoo-hoo! Here I am!”

BL Code	# in box	Value	# of parts	# of extras	Face sides	Gender	# of sales	Strength	Creativity	Speed
col11-8	6	\$3.52	5	0	1	M	603	5	2	3



Once upon a time, the Yeti was barely more than a legend. Dwelling all alone up on his snowy mountaintop, he was rarely glimpsed by travelers, and those who did spot him were even less often believed. The Yeti himself was starting to think that he might just be a myth.

But that changed the day he looked himself up on the internet. Everyone seemed to be talking about him there, and they knew all about him – from his favorite foods to his foot size. He was famous! Now that he knows he’s a celebrity, the no-longer-shy Yeti is just waiting for crowds of new friends to arrive. He can’t wait to meet them!



# Mountain Climber

“No cliff too steep, no peak too high!”

BL Code	# in box	Value	# of parts	# of extras	Face sides	Gender	# of sales	Strength	Creativity	Speed
col11-9	6	\$3.08	7	0	1	M	267	5	3	4



The Mountain Climber doesn't just like to climb – he's also a highly-trained and skilled rescue worker! If anybody gets stuck on a mountainside, he's the one who gets called in. Whether he's rappelling down from a helicopter in high winds or scaling up a snowy slope with medical supplies, he never gives up and he never loses hope.

And it's not just his fellow citizens that he helps, either. In his years of experience, the Mountain Climber has rescued stranded mountain goats, birds that have gotten lost in mid-migration, and even the **Yeti** once when a particularly loud yodel buried the creature in snow. After all that hard work, he's always got hot chocolate and soup waiting for him when the rescue's done!

# Welder

“Stand back. Things are gonna get hot.”

BL Code	# in box	Value	# of parts	# of extras	Face sides	Gender	# of sales	Strength	Creativity	Speed
col11-10	6	\$3.34	7	0	1	M	379	4	4	3

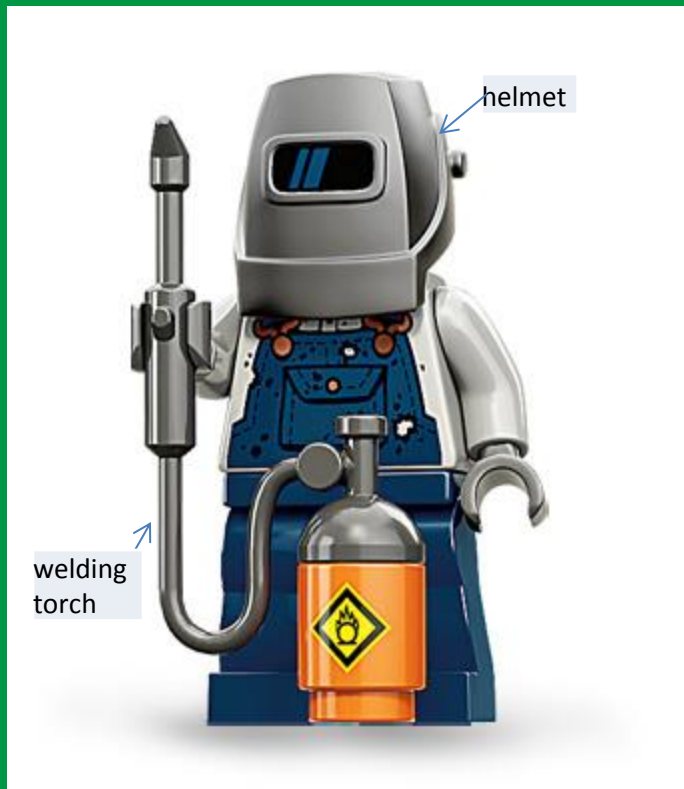

The Welder thrives on a good emergency. Give him a week to repair a broken deck plate and he'll yawn and put off the work until tomorrow, but tell him that he has 45 seconds to fix a cracked pipe or the whole sewage system will blow, and he'll jump into action and get it done just in the nick of time.

With a mask to shield his eyes from sparks and bright light, and heavy-duty overalls to protect the rest of him, the Welder sets to work with his welding torch in hand. As metal sizzles and the clock ticks down, his concentration never falters until the job is done, and done right. This is one Minifigure who can definitely take the heat!

# Scientist

“I wonder what will happen if I put THIS together with THAT...”

BL Code	# in box	Value	# of parts	# of extras	Face sides	Gender	# of sales	Strength	Creativity	Speed
col11-11	4	\$3.57	7	0	1	F	646	3	5	3

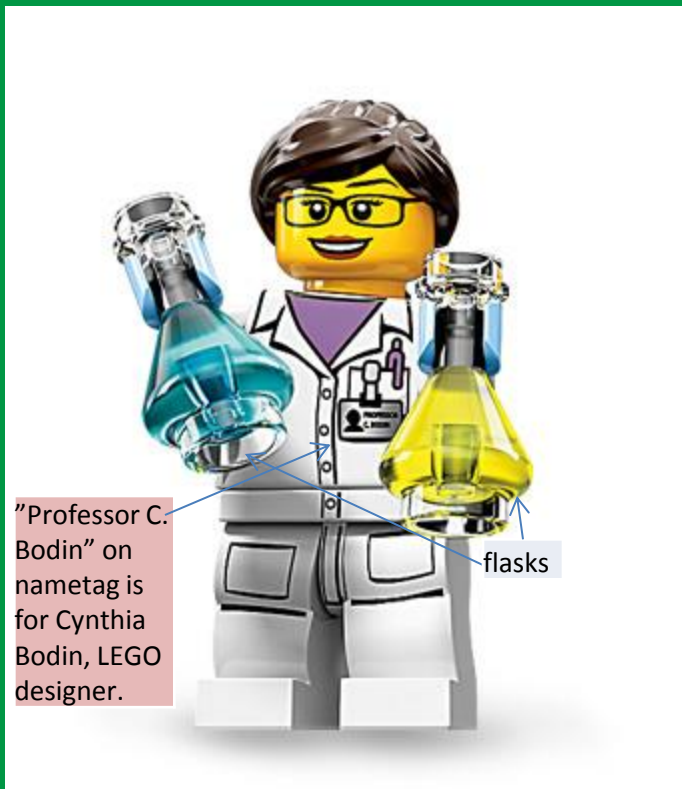

“Professor C. Bodin” on nametag is for Cynthia Bodin, LEGO designer.

flasks

The brilliant Scientist’s specialty is finding new and interesting ways to combine things together. She’ll spend all night in her lab analyzing how to connect bricks of different sizes and shapes (she won the coveted Nobrick Prize for her discovery of the theoretical System/DUPLO® Interface!), or how to mix two colors in one element.

Thanks to the Scientist’s tireless research, Minifigures that have misplaced their legs can now attach new pieces to let them swim like fish, slither like snakes, and stomp around like robots. Her studies of a certain outer dimension have even perfected a method for swapping body parts at will!

# Saxophone Player

Very  
Rare

“Let’s groove.”

BL Code	# in box	Value	# of parts	# of extras	Face sides	Gender	# of sales	Strength	Creativity	Speed
col11-12	2	\$4.53	6	0	1	M	564	3	4	3



The Saxophone Player is a Minifigure of few words. While others chatter away, he prefers to let his music do the talking for him. In the park, out on the street, or on stage at a nightclub, he picks up his saxophone and plays whatever thoughts and moods happen to be on his mind.

The Saxophone Player does not seek fame or fortune. He doesn't record albums, and he doesn't take requests. But if you stand quietly and listen to him play for a while, you might just start to understand what he's saying...and you might learn a thing or two, too.

# Diner Waitress

Very  
Rare

“Really? You’re sure that’s what you want?”

BL Code	# in box	Value	# of parts	# of extras	Face sides	Gender	# of sales	Strength	Creativity	Speed
col11-13	2	\$3.95	10	0	2	F	389	4	3	4



The Diner Waitress has a strong opinion about everything – the weather, today’s crossword puzzle, and especially the dishes that her customers order. If you want to eat what she thinks you should eat, then there’s no problem at all...but if you ask for the wrong thing, then up goes her eyebrow and you know you’re in trouble!

Oh, she’ll bring you your food promptly and courteously, even if you ask for peanut butter and jelly with gravy or roast chicken with a scoop of ice cream on top. But you’ll be able to tell by the way she looks at you as she rolls up on her skates that the Diner Waitress highly disapproves of your menu selection. Better leave a big tip!

# Grandma

Very  
Rare

“You look chilly! Would you like some warm milk and cookies?”

BL Code	# in box	Value	# of parts	# of extras	Face sides	Gender	# of sales	Strength	Creativity	Speed
col11-14	2	\$4.54	7	0	1	F	451	2	5	2



You won't find a sweeter lady in the whole wide LEGO® brick world than Grandma. Whether she is knitting on her porch rocking chair or baking a fresh apple pie, she's always happy to hear about your day and show you a few photos from her family album.

And the stories those photos tell about the people she's met and the places she's traveled! In her long and adventure-filled life, Grandma has dug for treasure with Johnny Thunder, sailed around the world with the **Fisherman**, and even gone into space. But she says that the very best adventure of all...is being a Grandma!

Bio references the LEGO Adventures theme.



# Constable

“Stop in the name of the law!”

BL Code	# in box	Value	# of parts	# of extras	Face sides	Gender	# of sales	Strength	Creativity	Speed
col11-15	6	\$3.25	6	0	1	M	419	5	3	4

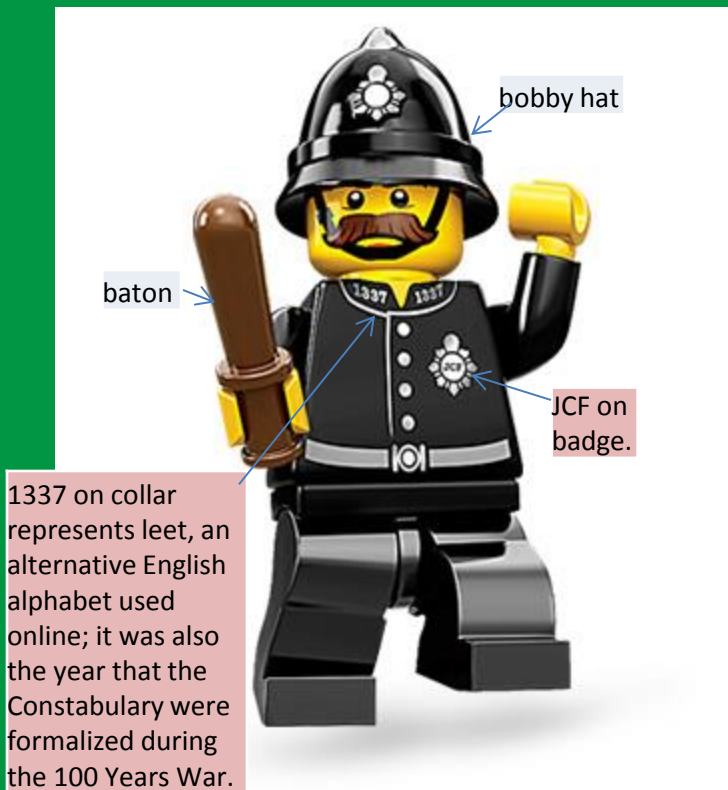

The Constable is an old-fashioned sort of policeman. He doesn't use a fancy squad car or motorcycle. Instead, he patrols the cobbled streets on foot, twirling his baton as he walks his daily route. He knows every law by heart, he always keeps his uniform neat, and he only takes off his helmet in the presence of the Queen.

The Constable often works with the **Detective** on important cases. He may not be able to solve every crime mystery all on his own, but everyone appreciates his pluck and enthusiasm, not to mention his extraordinary ability to get lawbreakers to give up simply by giving them a good talking-to!

# Lady Robot

“Par-ty par-ty par-ty!”

BL Code	# in box	Value	# of parts	# of extras	Face sides	Gender	# of sales	Strength	Creativity	Speed
col11-16	4	\$4.61	6	0	1	F	332	5	3	1



The Lady Robot was originally built to be a toy, just like the **Clockwork Robot**. But as soon as her cogs and gears sprang to life, it was clear that there was something that she liked even more – and that’s PARTYING! Nobody else can party like the Lady Robot. She never gets tired or runs out of energy, and thanks to her new and improved self-winding key, she can dance to the music 24 hours a day, 7 days a week. She’s even got a built-in karaoke machine. Some day she might decide she’s ready to stop partying...but not yet!

# Team GB – July 2012

Avg price ea	Avg # of parts (not incl extras)	F count	M count	N count	# Sold last 6 mos	MVP Price Name	MVP Price
£ 4.18	7	3	6	0	1132	Brawny Boxer	\$8.57

LVP Price Name	LVP price	MVP Qty Name	MVP Qty	LVP Qty Name	LVP qty	Avg Set Price	Avg Case Price
Agile Archer	\$ 5.97	Relay Runner	178	Judo Fighter	111	\$ 60.48	£ 248.73



# Team GB Series Stats

## Genders

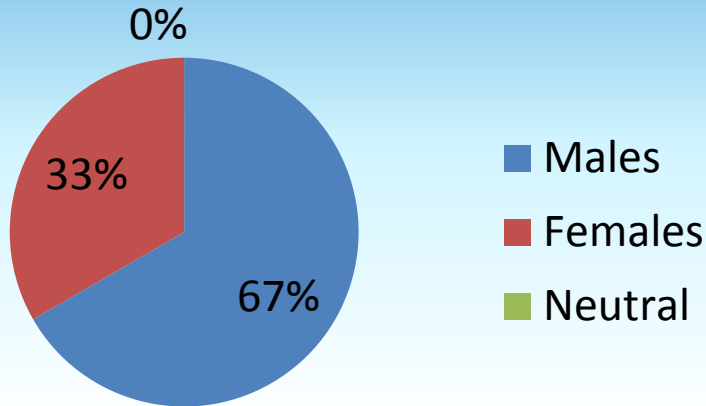

## Value

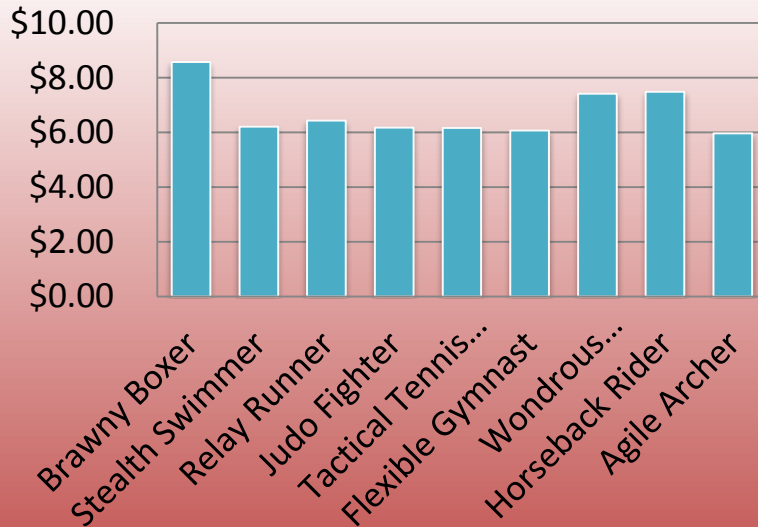

- Most Valuable = Brawny Boxer
- Most Popular = Agile Archer
- Least Valuable = Relay Runner
- Least Popular = Judo Fighter
- Average Set Value = \$60.48
- Average Figure Value = £4.18
- Average # of Pieces = 7
- Very Common figures:
  - Brawny Boxer
  - Wondrous Weightlifter
  - Horseback Rider

# Brawny Boxer



BL Code	# in box	Value	# of parts	# of extras	Face sides	Gender	# of sales	Strength	Creativity	Speed
coltgb-1	6	\$8.57	6	0	1	M	129	?	?	?



Punching his way to the top, this lean machine in blue is ready to float like a butterfly and sting like a bee for Team GB!

# Stealth Swimmer

BL Code	# in box	Value	# of parts	# of extras	Face sides	Gender	# of sales	Strength	Creativity	Speed
coltgb-2	7	\$6.21	6	0	1	M	107	?	?	?



Like a fish in the water, the Stealth Swimmer is ready to torpedo through the water into to pole position.



# Relay Runner

BL Code	# in box	Value	# of parts	# of extras	Face sides	Gender	# of sales	Strength	Creativity	Speed
coltgb-3	7	\$6.43	7	0	1	M	178	?	?	?



Sprinting to reach the winning line, could this give Team GB a relay team victory?

# Judo Fighter

BL Code	# in box	Value	# of parts	# of extras	Face sides	Gender	# of sales	Strength	Creativity	Speed
coltgb-4	7	\$6.18	6	0	1	F	111	?	?	?



Taking down her opponents one at a time, this mistress of martial arts knocks down anything in her way to grasp that gold medal.

The Judo Fighter is the only Minifigure in this series to have back printing.

# Tactical Tennis Player

BL Code	# in box	Value	# of parts	# of extras	Face sides	Gender	# of sales	Strength	Creativity	Speed
coltgb-5	7	\$6.16	7	0	1	M	112	?	?	?



First on the court in his gleaming whites, this tennis ace will knock the white socks off of any competition.

# Flexible Gymnast

BL Code	# in box	Value	# of parts	# of extras	Face sides	Gender	# of sales	Strength	Creativity	Speed
coltgb-6	7	\$6.07	9	0	1	F	124	?	?	?



Balance and coordination is the name of the game for this agile Olympic contender.

# Wondrous Weightlifter

BL Code	# in box	Value	# of parts	# of extras	Face sides	Gender	# of sales	Strength	Creativity	Speed
coltgb-7	6	\$7.41	9	0	1	M	117	?	?	?



Powerlifting his personal best, the crowd looks on as this burley guy weighs up his chances of going for gold.

# Horseback Rider

BL Code	# in box	Value	# of parts	# of extras	Face sides	Gender	# of sales	Strength	Creativity	Speed
coltgb-8	6	\$7.48	6	0	1	F	141	?	?	?



hat

medal

Hat first seen in Friends Summer Riding Camp Minidoll. This is the first time a minidoll accessory has been included with a minifigure.

Has rare inner leg printing.

Riding her way to the last hurdle, this athlete won't be horsing around when it comes to winning!



# Agile Archer



BL Code	# in box	Value	# of parts	# of extras	Face sides	Gender	# of sales	Strength	Creativity	Speed
coltgb-9	7	\$5.97	7	0	1	M	113	?	?	?

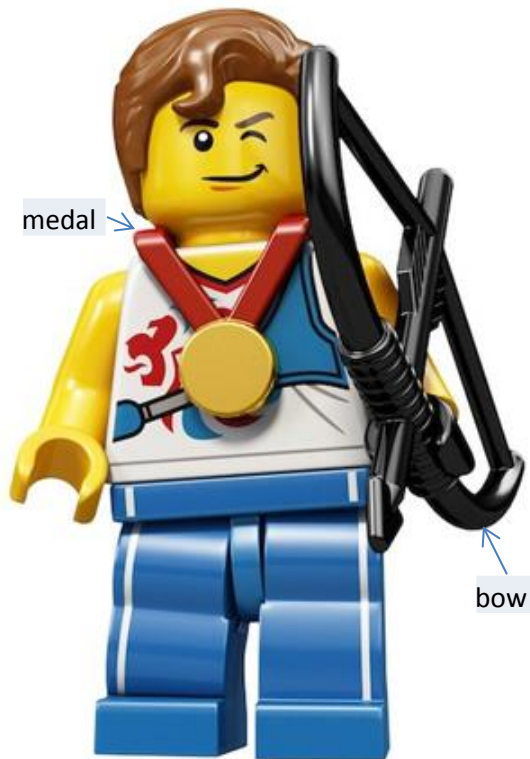

Complete with bow in hand, let's hope this little fella will be on target on the day!

# Toy Soldier

Exclusive to the *LEGO Minifigures Character Encyclopedia*.

BL Code	# in book	Value	# of parts	# of extras	Face sides	Gender	# of sales	Strength	Creativity	Speed
col162	1	\$13.35	8	0	1	M	143	?	?	?



No matter where his journey may take him, through city and country, or to distant worlds, the Toy Soldier has a cheery smile and a certainty that he will get wherever he is trying to go. When he finally reaches his destination, he can't wait for the next big adventure to start.

# Minifigures: The Online Game

Coming in 2014!



THE ONLINE GAME  
COMING 2014



Get ready to meet the Minifigures! Collect them all and bring them with you on grand adventures in *LEGO Minifigures Online* – an epic online adventure where you get to explore colorful locations such as Pirate World, Space World and Medieval World! Play together with thousands of other players and battle your way through monstrous riff-raff as you develop your Minifigures' unique and powerful abilities. Smash, build and collect – thousands of exciting adventures are just a brick away in *LEGO Minifigures Online*!

Explore many wondrous LEGO worlds each teeming with life, detail and awesome adventure! From lush islands held by swashbuckling pirates to alien worlds where the **Galaxy Patrol** must battle dangers such as the mind-controlling Pluuvian Brain-Beast!

Find, collect and play with almost one hundred different Minifigures! The **Ice Skater**, the **Chicken Suit Guy**, the **Roller Derby Girl**, **Alien Avenger** and many, many more; millions of LEGO fans all over the world have held them in their hands and now they can step into their shoes as they explore the world of LEGO Minifigures Online!

Interact with the environment around you and use it to your advantage! Smash an enemy turret and re-build it to work for you, destroy a wall to discover a hidden passage and even build machines to help you take down the big bosses! Smashing stuff definitely feels good, but as all LEGO fans will know, building something feels even better!

Compete or collaborate with friends from all over the world! Face the adventure together or engage in awesome player vs. player battles where you must build towers, traps, mines and turrets while taking on the enemy and smashing theirs!

Discover unique abilities with each Minifigure! Take control of the rocked-out **DJ** and literally drop your beats on unsuspecting enemies, or assume the role of the **Aztec Warrior** and go to battle making sure no one is spared your mighty spear! Maybe the **Plumber** is your guy? Sure! A plunger in the face will stop those baddies!

Gather experience and level up Minifigures by smashing your way through enemies, rocks and LEGO bricks! Customize your playstyle by collecting special bricks and put them together in unique shapes to upgrade abilities such as luck and creativity!

There are hundreds of different characters available in the LEGO Minifigures line and Funcom will continuously keep adding more and more of these for players to collect in-game! Funcom and The LEGO Group are working closely together to blend the physical world of LEGO Minifigures with the digital one; for instance players who purchase bags containing real Minifigure will immediately be able to jump into the game and play with their virtual counterparts!

Unravel an exciting story that spans across worlds! Take on quests such as searching for buried treasure in the pirate world, rescuing the kidnapped king in the medieval world, and even helping Zeus himself in the mythology world!

# Index

Agile Archer, p. 222  
Alien Avenger, p. 169  
Alien Villainess, p. 156  
Artist, p. 82  
Aztec Warrior, p. 124  
Bagpiper, p. 128  
Bandit, p. 109  
Barbarian, p. 196  
Baseball Fielder, p. 189  
Baseball Player, p. 66  
Battle Mech, p. 171  
Boxer, p. 99  
Brawny Boxer, p. 214  
Bride, p. 126  
Bumblebee Girl, p. 183  
Bunny Suit Guy, p. 125  
Businessman, p. 148  
Butcher, p. 118  
Cave Woman, p. 91  
Caveman, p. 17  
Cheerleader, p. 16  
Chicken Suit Guy, p. 165  
Circus Clown, p. 18  
Classic Alien, p. 105  
Clockwork Robot, p. 111  
Computer Programmer, p. 134  
Conquistador, p. 142  
Constable, p. 210  
Cowboy, p. 30  
Cowgirl, p. 144  
Crazy Scientist, p. 84  
Cyclops, p. 160  
Daredevil, p. 129  
Decorator, p. 191  
Deep Sea Diver, p. 29  
Demolition Dummy, p. 22  
Detective, p. 97  
Diner Waitress, p. 208

Disco Dude, p. 45  
Diver, p. 146  
DJ, p. 152  
Downhill Skier, p. 147  
Egyptian Queen, p. 100  
Elf, p. 59  
Evil Dwarf, p. 98  
Evil Knight, p. 136  
Evil Mech, p. 199  
Evil Robot, p. 141  
Explorer, p. 39  
Fairy, p. 149  
Fisherman, p. 51  
Fitness Instructor, p. 96  
Flamenco Dancer, p. 110  
Flexible Gymnast, p. 219  
Football Player, p. 145  
Forest Maiden, p. 173  
Forestman, p. 28  
Fortune Teller, p. 167  
Galaxy Patrol, p. 130  
Gangster, p. 101  
Genie, p. 120  
Gingerbread Man, p. 201  
Gladiator, p. 88  
Gorilla Suit Guy, p. 62  
Graduate, p. 87  
Grandma , p. 209  
Grandma Visitor, p. 138  
Grandpa, p. 184  
Hazmat Guy, p. 81  
Heroic Knight, p. 162  
Highland Battler, p. 106  
Hippie, p. 133  
Hockey Player, p. 76  
Holiday Elf, p. 202  
Hollywood Starlet, p. 161  
Horseback Rider, p. 221

Hula Dancer, p. 64  
Ice Fisherman, p. 90  
Ice Skater, p. 83  
Intergalactic Girl, p. 117  
Island Warrior, p. 200  
Judge, p. 168  
Judo Fighter, p. 217  
Jungle Boy, p. 132  
Karate Master, p. 46  
Kimono Girl, p. 70  
Lady Liberty, p. 108  
Lady Robot, p. 211  
Lawn Gnome, p. 69  
Lederhosen Guy, p. 143  
Leprechaun, p. 113  
Librarian, p. 177  
Lifeguard, p. 40  
Lizard Man, p. 92  
Lumberjack, p. 94  
Magician, p. 23  
Maraca Man, p. 33  
Mechanic, p. 119  
Medusa, p. 178  
Mermaid, p. 170  
Mime, p. 41  
Minotaur, p. 112  
Motorcycle Mechanic, p. 192  
Mountain Climber, p. 204  
Mr. Gold, p. 193  
Mr. Good and Evil, p. 172  
Mummy, p. 58  
Musketeer, p. 71  
Ninja, p. 26  
Nurse, p. 25  
Ocean King, p. 127  
Paintball Player, p. 185  
Pharaoh, p. 48  
Pilot, p. 52

Pirate Captain, p. 155  
Plumber, p. 174  
Policeman, p. 164  
Pop Star, p. 43  
Pretzel Girl, p. 198  
Punk Rocker, p. 72  
Race Car Driver, p. 61  
Rapper, p. 65  
Red Cheerleader, p. 153  
Relay Runner, p. 216  
Revolutionary Soldier, p. 188  
Ringmaster, p. 35  
Robot, p. 21  
Rocker Girl, p. 137  
Roller Derby Girl, p. 166  
Roman Commander, p. 179  
Roman Emperor, p. 163  
Roman Soldier, p. 114  
Royal Guard, p. 89  
Sad Clown, p. 187  
Sailor, p. 78  
Samurai Warrior, p. 54  
Santa, p. 150  
Saxophone Player, p. 207  
Scarecrow, p. 197  
Scientist, p. 206  
Sea Captain, p. 186  
Skater Girl, p. 116  
Skater, p. 20  
Skier, p. 44  
Skydiver, p. 182  
Sleepyhead, p. 107  
Small Clown, p. 95  
Snowboarder Guy, p. 102  
Snowboarder, p. 55  
Soccer Player, p. 79  
Space Alien, p. 63  
Space Villain, p. 56

Spaceman, p. 27  
Spartan Warrior, p. 34  
Stealth Swimmer, p. 215  
Street Skater, p. 77  
Sumo Wrestler, p. 57  
Super Wrestler, p. 24  
Surfer Girl, p. 73  
Surfer, p. 47  
Surgeon, p. 115  
Swimming Champion, p. 123  
Tactical Tennis Player, p. 218  
Tennis Ace, p. 131  
Tennis Player, p. 60  
The Monster, p. 75  
The Thespian, p. 154  
Tomahawk Warrior, p. 181  
Toy Soldier, p. 223  
Traffic Cop, p. 38  
Trendsetter, p. 190  
Tribal Chief, p. 53  
Tribal Hunter, p. 15  
Vampire Bat, p. 151  
Vampire, p. 37  
Viking Woman, p. 135  
Viking, p. 74  
Waiter, p. 159  
Warrior Woman, p. 180  
Weightlifter, p. 42  
Welder, p. 205  
Werewolf, p. 80  
Witch, p. 36  
Wondrous Weightlifter, p. 220  
Yeti, p. 203  
Zombie, p. 19  
Zookeeper, p. 93



