

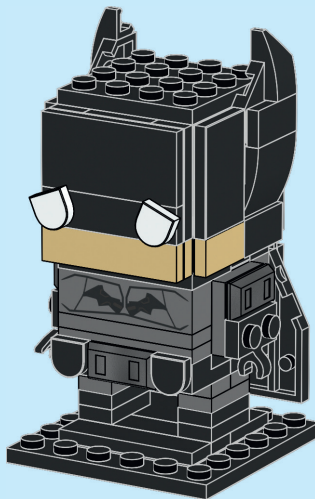

# BRICK HEADZ

40748

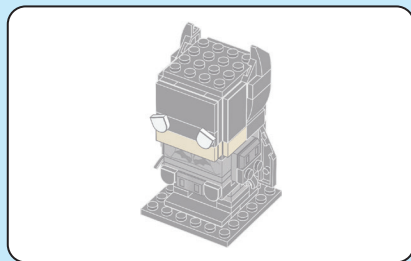



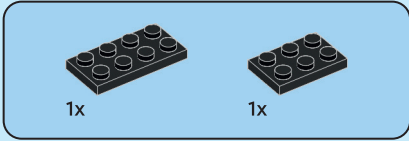

1

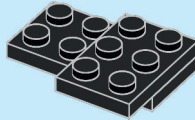

3

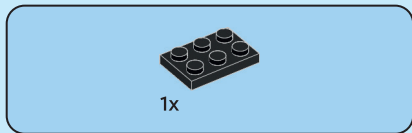

2

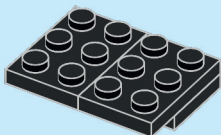

4

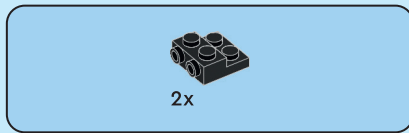
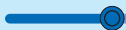

3

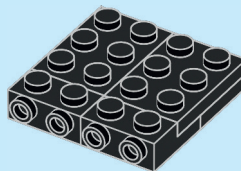



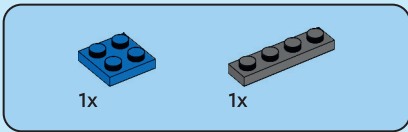

4

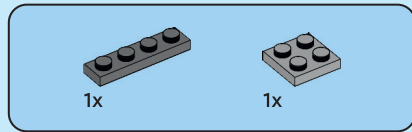
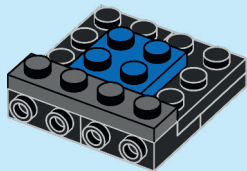

5

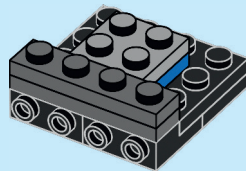

5

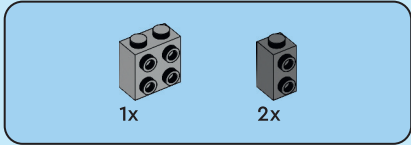

6

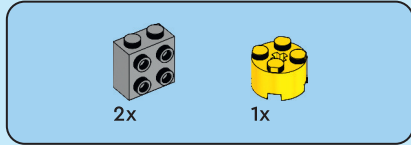
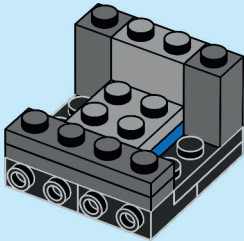

7

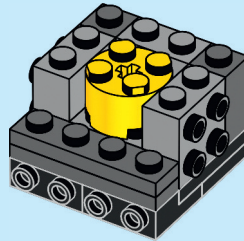

6



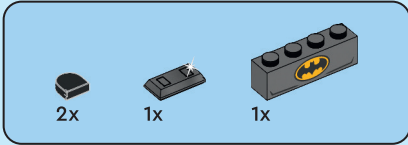

8

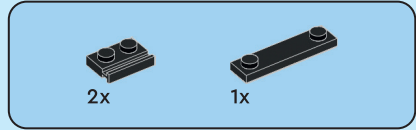
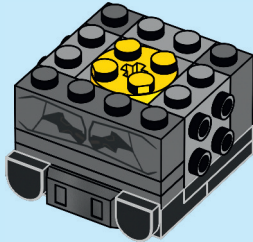

9



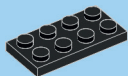

1x

10

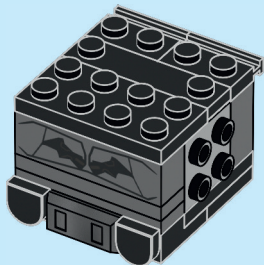

8



3x

11

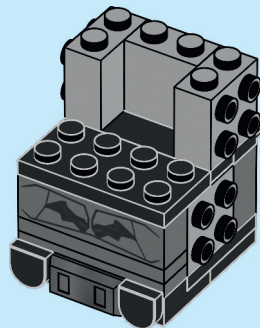

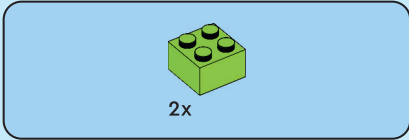

12

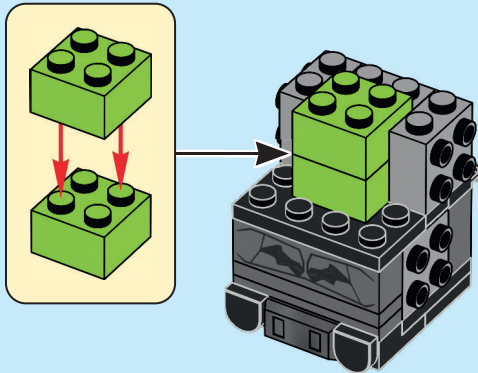

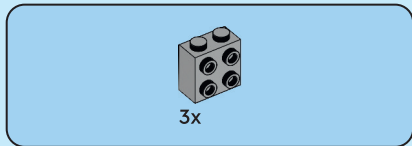

13

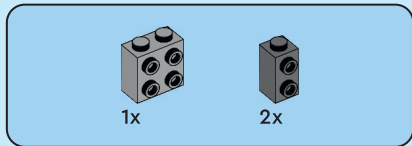
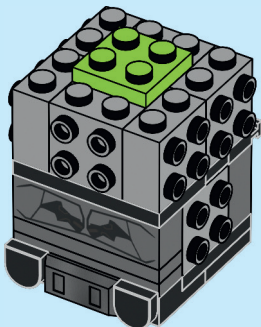

14

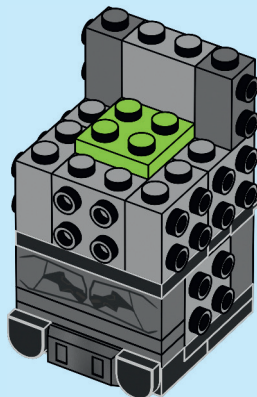

10



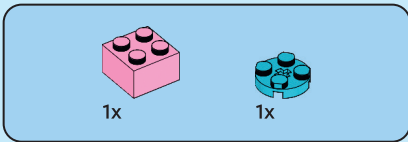

15

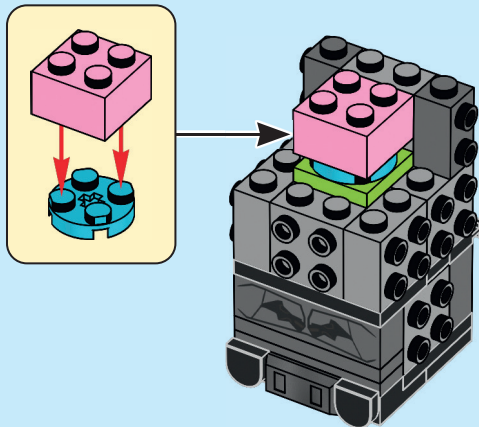

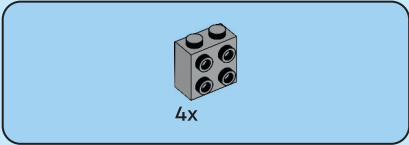

16

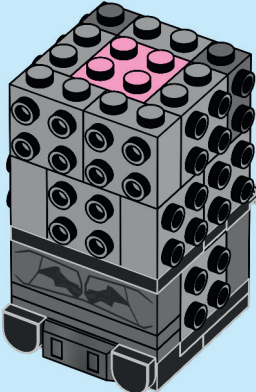

12

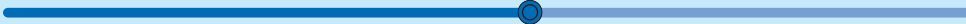



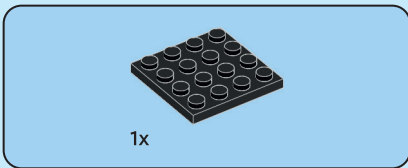

17

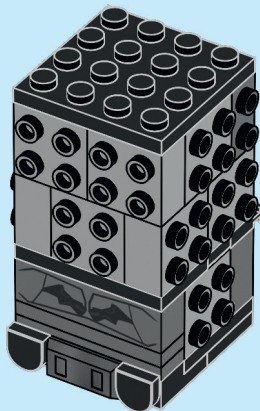

13

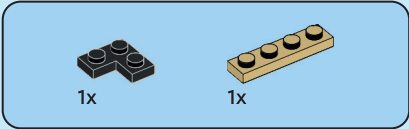

18

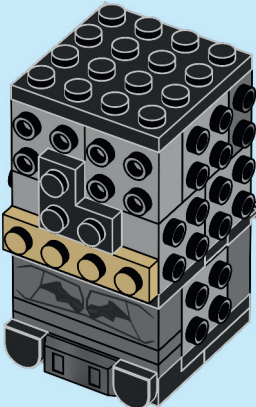

14

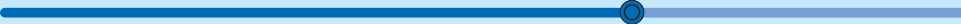



1x



2x

19

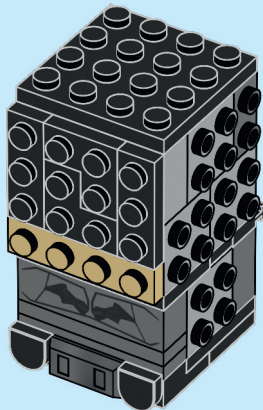

15

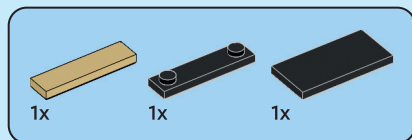

20

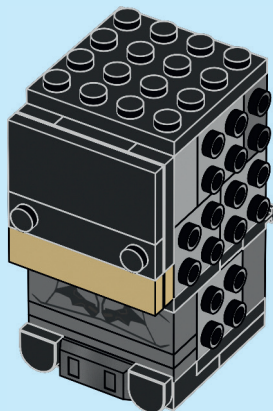

16



2x

21

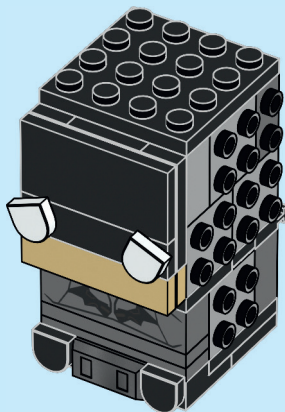

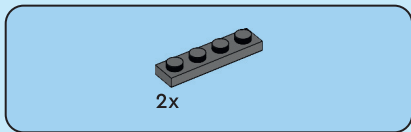

22

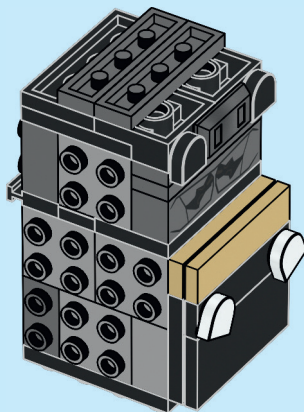

18

---

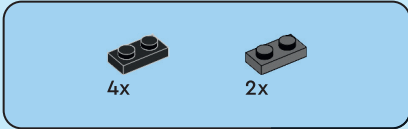

23

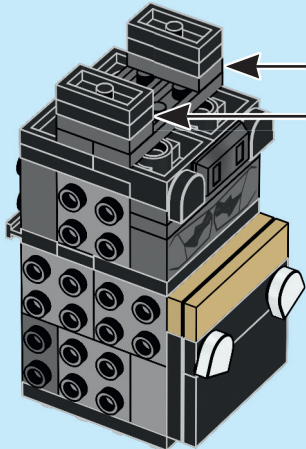
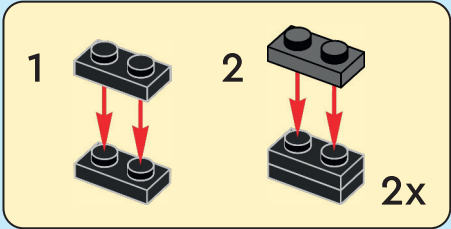

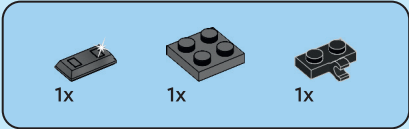

24

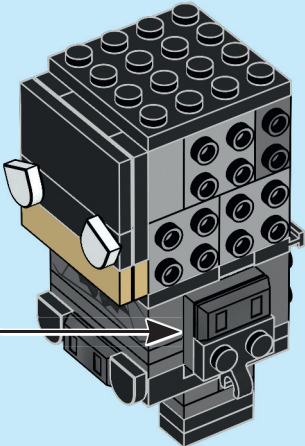
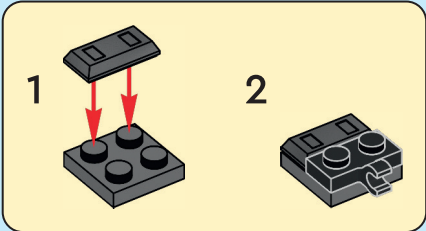



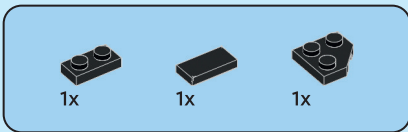

25

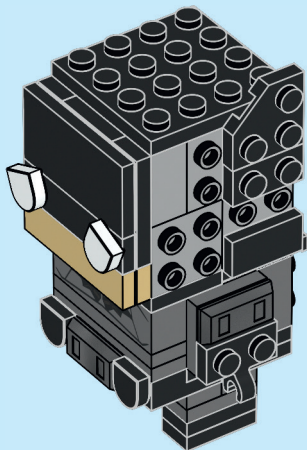

21

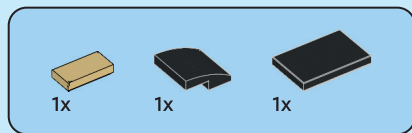

26

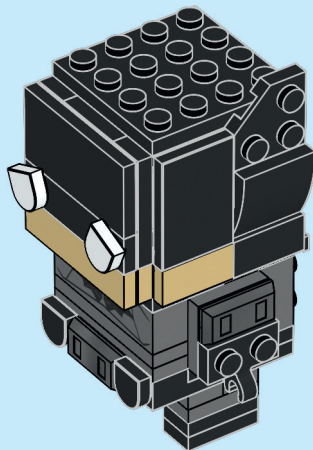

22

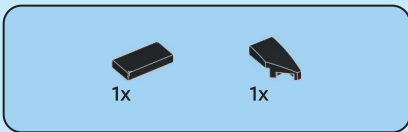

27

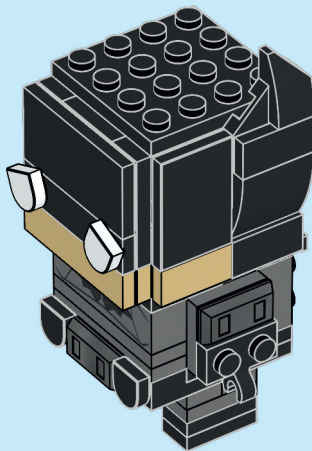

23

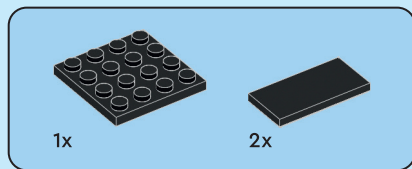

28

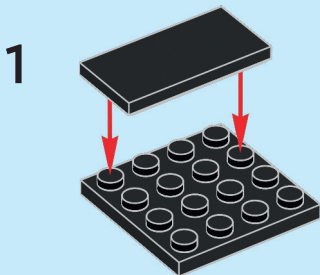

2

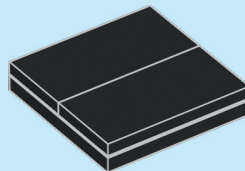

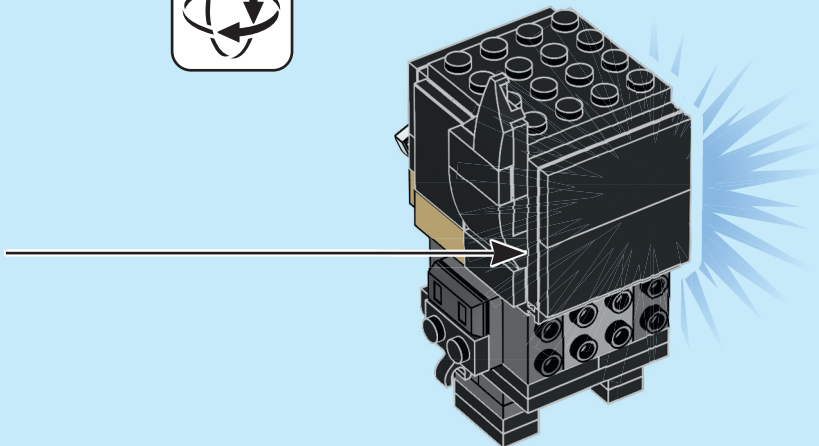

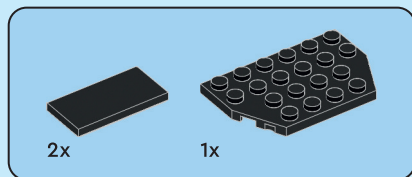

29

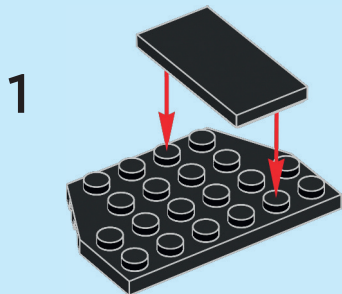

2

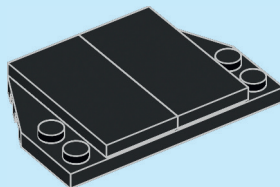

26

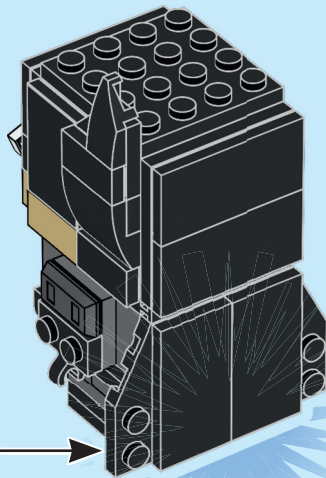

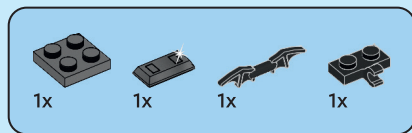

30

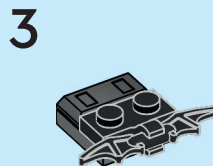
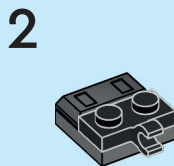
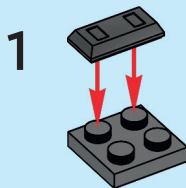

28

---



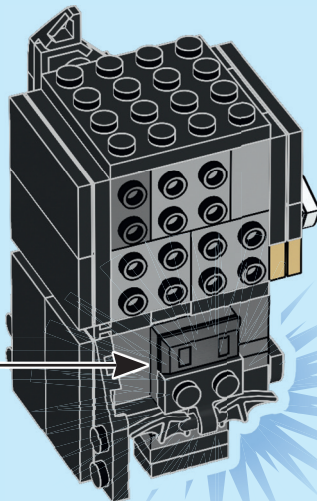

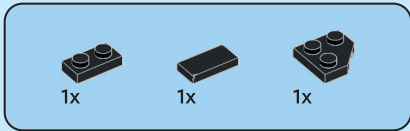

31

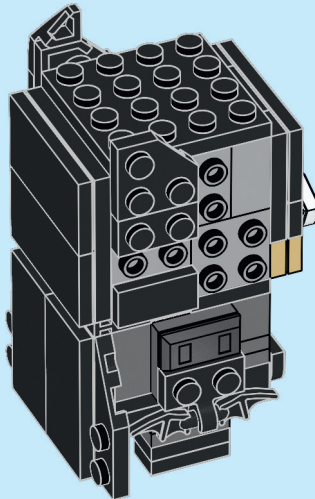

30

---

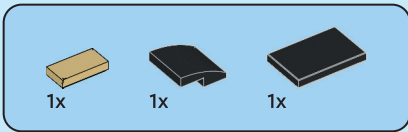

32

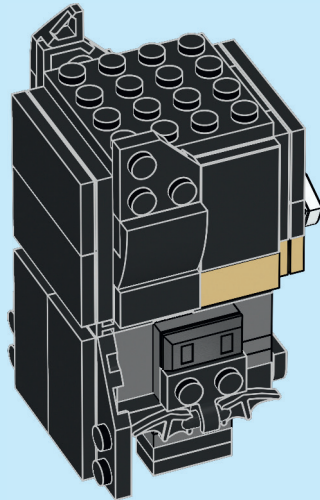

31

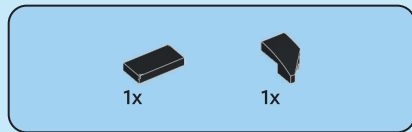

33

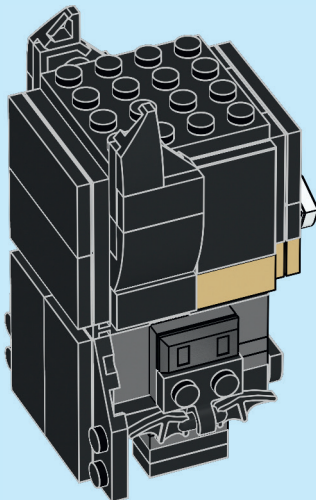

32

---

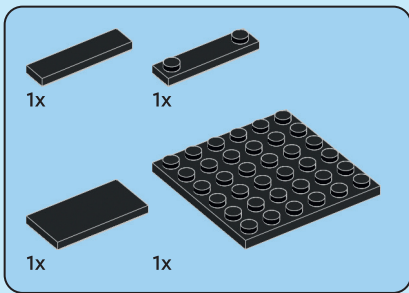

# 34

1

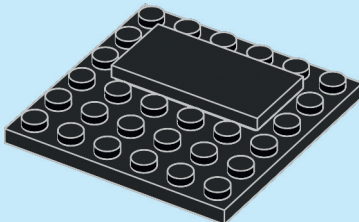

2

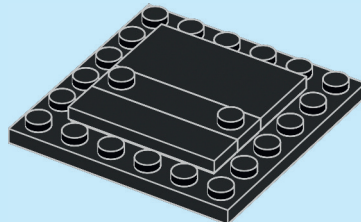

33

